























Ref.	R.O.	Peso Weight Peso
TEN01202	55320-98600 Cinc / Zinc / Zinco	0,095kg

**MOTORES / ENGINES / MOTORI**  
Fuerabordas / Outboards / Fuoribordo



Ref.	R.O.	Peso Weight Peso
TEN01205	11130-94600 Cinc / Zinc / Zinco	0,010 kg

**MOTORES / ENGINES / MOTORI**  
Fuerabordas / Outboards / Fuoribordo



Ref.	R.O.	Peso Weight Peso
TEN01206	55321-93900 Cinc / Zinc / Zinco	0,050 kg

**MOTORES / ENGINES / MOTORI**  
Serie 9.9 / 15 HP



Ref.	R.O.	Peso Weight Peso
TEN01207	55321-95500 Cinc / Zinc / Zinco	0,190 kg

**MOTORES / ENGINES / MOTORI**  
Serie 75 - 85 - 90 HP



Ref.	R.O.	Peso Weight Peso
TEN01209	55321-94502 Cinc / Zinc / Zinco	0,330 kg

**MOTORES / ENGINES / MOTORI**  
Serie 115 HP



## MOTORES DE ARRANQUE STARTERS MOTORINI AVVIAMENTO

Ref.	R.O.	Tiempos Strokes Tempi
PH130-0006	31100-96310/11, 31100-94400/01/002, 31100-89J00	2 / 4

**MOTORES / ENGINES / MOTORI**

DF25 - DF30Y-K6 (2000-06)  
DF25A - DF30A (2015+)  
DT20 - DT25 - DT30G-Y (1986-00)  
DT40C-WG-X (1986-99)  
8 Dientes / 8 tooth / 8 denti



Ref.	R.O.	Tiempos Strokes Tempi
PH130-0060	31100-95600/01, 31100-95310/12/13	2

**MOTORES / ENGINES / MOTORI**

DT75-DT85Y-J (1988-00)  
9 Dientes / 9 tooth / 9 denti



Ref.	R.O.	Tiempos Strokes Tempi
PH130-0052	31100-87000, 31100-87D00, 31100-87D10, 31100-92E00	2

**MOTORES / ENGINES / MOTORI**

DT90 - DT100L - Y (1990-00)  
DT150 - DT200 - DT225W-K3 (1998-03)  
V6H-Y (1987-00)  
8 Dientes / 8 tooth / 8 denti



Ref.	R.O.	Tiempos Strokes Tempi
PH130-0053	31100-94600, 31100-94601, 31100-94610, 31100-94500/10/11/12	2

**MOTORES / ENGINES / MOTORI**

DT115 - DT140G-Y (1986-00)  
9 Dientes / 9 tooth / 9 denti



Ref.	R.O.	Tiempos Strokes Tempi
PH130-0007	31100-95240, 31100-95242, 31100-95243	2

**MOTORES / ENGINES / MOTORI**

DT50 (1980-83)  
DT65 (1980-82)  
9 Dientes / 9 tooth / 9 denti



Ref.	R.O.	Tiempos Strokes Tempi
PH130-0075	31100-94702	2

**MOTORES / ENGINES / MOTORI**

DT55 - DT65X-J (1988-99)

9 Dientes / 9 tooth / 9 denti



Ref.	R.O.	Tiempos Strokes Tempi
PH130-0079	31100-87J00, 31100-87J11	4

**MOTORES / ENGINES / MOTORI**

DF40 - DF50X-K10 (1999-10)  
DF60 - DF70W-K9 (1998-09)

8 Dientes / 8 tooth / 8 denti



Ref.	R.O.	Tiempos Strokes Tempi
PH130-0077	31100-95J00, 31100-95J01	4

**MOTORES / ENGINES / MOTORI**

DF20R (2006-2011)  
DF25 / DF25R-V2 (2006-11)

9 Dientes / 9 tooth / 9 denti



Ref.	R.O.	Tiempos Strokes Tempi
PH130-0071	31100-90J00, 31100-90J01	4

**MOTORES / ENGINES / MOTORI**

DF90 - DF100 - DF115K1-K11 (2001-11)  
DF110A - DF115A - DF140A (2013+)  
DF140 (2002-2012)  
DF140A (2013)

9 Dientes / 9 tooth / 9 denti

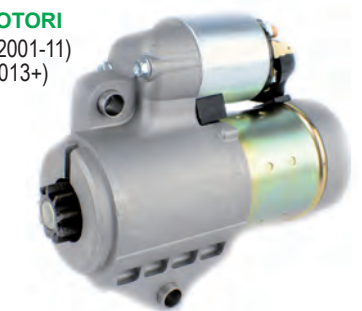

Ref.	R.O.	Tiempos Strokes Tempi
PH130-0078	31100-96J01, 31100-96J00, 31100-93J00	4

**MOTORES / ENGINES / MOTORI**

DF70A - DF80A - DF90A (2009+)  
DF150G/T/Z (2006+)  
DF175G/T/Z (2006+)  
DF200 - DF 225 - / DF250 (2004-2012)  
DF300T/Z (2007-2011)  
DF300AP (2012)

9 Dientes / 9 tooth / 9 denti



# MOTORES TRIM Y POWERTRIM TRIM ENGINES AND COMPLETE TRIM MOTORINI TRIM E POWERTRIM

## INSTALACIÓN ELÉCTRICA WIRING HARNESS ISTALLAZIONE ELETTRICA

Ref.	R.O.
PH200-WH01	

Sustituye de 2 a 3 cables.  
Converts 3-wire Tilt and Trim motors to 2-Wire design  
Sustituisce da 2 a 3 cavi.



## TRIM COMPLETO COMPLETE TRIM ASSEMBLY MOTORINO TRIM COMPLETO

Ref.	R.O.
SIE18-6865	48600-94511OED

**MOTORES / ENGINES / MOTORI**

3 RAM  
115-225HP



Ref.	R.O.	Tiempos Strokes Tempi
REC38100-96J00	38100-92J02, 38100-92J10, 38100-92J01, 38100-93J02, 38100-96J00, 38100-96J01	4

**MOTORES / ENGINES / MOTORI**

DF90 / DF100 / DF115K1-K11 (2001-11)  
DF200 / DF225 / DF250 (2004-11)  
DF300T/Z (2007-2011)  
DF150T/Z (2006-12)



Ref.	R.O.	Tiempos Strokes Tempi
REC38100-87J00	37100-87J00-OEP, 38100-87JOEP	4

**MOTORES / ENGINES / MOTORI**

DF40/DF50X-K10 (1999-10)  
TMY99-00



Ref.	R.O.	Tiempos Strokes Tempi
PH200-T046	38100-87J11, 38100-87J20	4

**MOTORES / ENGINES / MOTORI**

DF40 / DF50X-K10 (1999-2010)





Ref.	R.O.	Tiempos Strokes Tempi
REC38100-99E01-0EP	38100-95E01-OED, 38100-99E01-OEP	2 / 4

**MOTORES / ENGINES / MOTORI**

DF60 / DF70W-K9 (1998-09)  
DF55 / DT65J-X (1988-99)  
DT75 / DT85J-Y (1988-00)



Ref.	R.O.	Tiempos Strokes Tempi
REC38100-87E10-OED	38100-87D00, OIT 38100-87D00, 02H 38100-87E10-OED	2

**MOTORES / ENGINES / MOTORI**

DT90 - DT100L-Y (1990-00)



Ref.	R.O.	Tiempos Strokes Tempi
PH200-T024	38100-87D10-OED 38100-87D10-35J 38100-87D10-OIT 38100-92E00-OED	2

**MOTORES / ENGINES / MOTORI**

DT150 - DT200 - DT225W-K3 (1998-03)  
V6H-Y (1987-00)



**REGULADORES,  
BOBINAS Y CDI  
REGULATORS,  
COILS & CDI  
REGOLATORI,  
BOBINE E CDI**

**REGULADOR Y BOBINA  
REGULATOR & COIL  
REGOLATORE E BOBINE**

Ref.	R.O.
REC32900-94480	32900-94401, 32900-94421, 32900-94480

**MOTORES / ENGINES / MOTORI**

DT40C-W-X-G (1986-99)



**REGULADOR  
REGULATOR  
REGOLATORE**

Ref.	R.O.
REC32800-95001	32800-95D01

**MOTORES / ENGINES / MOTORI**

DF9.9 / DF15 (1996-11)  
DT4-DT140 (1986-04)  
V6 H-Y (1987-00)



**BOBINA / COIL / BOBINE**

Ref.	R.O.
REC33410-94400-000	33410-94400-000 33410-93E10

**MOTORES / ENGINES / MOTORI**

DF9.9 - DF15T -K3 (1996-03)  
DF9.9 - DF15(R)' (2004-10)  
DT40C-W-G-X (1986-99)  
DT40W-K1-K4 (2001-04)



Ref.	R.O.
REC32140-93900	32140-93900

**MOTORES / ENGINES / MOTORI**

DT9.9 / DT15K1-K4 (2001-04)  
DT9.9K / DT15K-G-Y (1986-00)



Ref.	R.O.
REC32900-96340	32900-96340

**MOTORES / ENGINES / MOTORI**

DT20 / DT25 / DT30G-Y (1986-00)



Ref.	R.O.
REC32900-93903	32900-93903, 32900-93902

**MOTORES / ENGINES / MOTORI**

DT9.9K / DT15G-Y (1986-00)



**CDI**

Ref.	R.O.
REC32900-93910	32900-93911

**MOTORES / ENGINES / MOTORI**

DT9.9K / DT15K-G-Y (1986-00)



Ref.	R.O.
REC32900-96371	32900-96371, 32900-96350 32900-96370

**MOTORES / ENGINES / MOTORI**

DT20 / DT25 / DT30G-Y (1986-00)  
DT25 / DT30K1-K2 (2001-02)

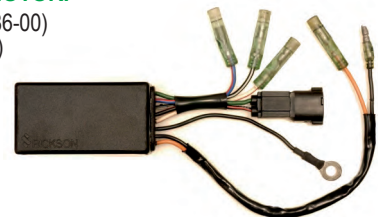

Ref.	R.O.
REC32900-94460	32900-94460, 32900-94470

**MOTORES / ENGINES / MOTORI**

DT40C-W-G-X (1986-99)  
DT40WK1-K4 (2001-04)



# LLAVE DE ARRANQUE IGNITION STARTER SWITCH CHIAVI DI ACCENSIONE

Ref. R.O.  
REC37110-99E00 37110-99E00

MOTORES / ENGINES / MOTORI  
2/4 Tiempos / Strokes / tempi



# DESCONECTORES DE SEGURIDAD CUT OFF SWITCHES CHIAVETTA DI SICUREZZA

Ref. R.O.  
REC37800-9354 37800-93954, 37800-93953

MOTORES / ENGINES / MOTORI

DT2 / DT2.2G-Y (1986-00)  
DT20 / DT25 / DT30G-Y (1986-00)  
DT25 / DT30K1-K2 (2001-02)  
DT40G-X-W-C (1986-99)  
DT9.9 / DT15K1-K5 (2001-04)  
DT9.9K / DT15K-G-Y (1986-00)



Ref. R.O.  
REC37830-89E03 37830-95000, 37830-89E02

MOTORES / ENGINES / MOTORI

DT15C (1989-97)  
DT9.9 / DT15K1-K4 (1986-00)  
DT4/J4/DT5Y (1988-97)  
DT5Y (1998-02)  
DT5 / DT6 / DT8Y-G (1986-00)  
DT6 / DT8Y-K2 (2000-02)  
DT8 / DT9.9C-J-V (1988-97)  
DT9.9K / DT15K-G-Y (1986-00)  
DT75 / DT85Y-J (1988-00)



Ref. R.O.  
REC37820-92E03 37820-92E00

MOTORES / ENGINES / MOTORI

DT4 / DT140HP  
DF9.9 / DF140 HP  
V6H-Y



# INTERRUPTOR DE PARO STOP SWITCH INTERRUPTORE DI STOP

Ref.	Características / Features / Caratteristiche	Envase / Pack / Qnt
THKS-1	Un fueraborda / Single outboard / Un fuoribordo	1 x blister
THKS-2	Un intraborda / Single I/O / Un entrobordeo	1 x blister
THKS-12	Dos fuerabordas / Dual outboard / Due fuoribordo	1 x blister
THKS-22	Dos intrabordas / Dual I/O / Due entrobordeo	1 x blister
THL-4	Cuerda recambio / Spare lanyard / Corda ricambio	1 x blister

Interruptor de encendido para motores.  
Aísla los circuitos en unidades dobles  
para prevenir el retorno al alternador.  
Emergency and stop switch. Isolates  
circuits on dual units to prevent  
feedback.

Interruttore di accensione per motori.  
Isola i circuiti in doppie unità per pre-  
venire il ritorno all'alternatore.



## KITS

Interruptor de encendido para todo tipo de motores fueraborda o intraborda.  
Emergency and stop switch for inboard or outboards.  
Interruttore di accensione per tutti i tipi di motori fuoribordo o entrobordeo.

Ref.		Envase / Pack / Qnt
REC40970	Kit completo / Complete kit / Kit completo	1 x blister
REC40990	Cuerda tirador de recambio / Spare Corda elastica di ricambio	1 x blister
GS11290	Kit completo / Complete kit / Kit completo	1 x blister
GS11291	Cuerda tirador de recambio / Spare Corda elastica di ricambio	1 x blister
GS11292	Kit completo / Complete kit / Kit completo	1 x blister

**GOLDENSHIP**



REC40970 - REC40990

GS11290 - GS11291



GS11292

**GOLDENSHIP**

Ref.	Envase / Pack / Qnt
GS11294	1 x blister

**GOLDENSHIP**

Kit de 8 llaves de recambio para:  
Kit of 8 spare keys for:  
Kit di 8 chiavi di ricambi per:  
J/E, OMC, Mercury, Yamaha, Honda,  
Suzuki, Tohatsu.



# CABLE ACELERADOR THROTTLE CABLE CAVO ACCELERATOR

Ref.	R.O.	HP	ANO YEAR ANNO
REC63610-89E01	63610-89E01-000	DT15C	1989-97
REC63610-93501	63610-93501-000	DT9.9 - 16	1982-92
REC63610-96302	63610-96302-000 (L=490 mm)	D20 / DT25 / DTG-Y	1986-00
REC63610-96321-000	63610-96321-000 (L=560 mm)	DT9.9K / DT15K-G-Y	1986-00
		DT9.9 / DT15K1-K4	2001-04
REC63610-94402	63610-94402-000	DT40C-W-G-X	1986-99
		DT40W-K1-K4	2001-04



# BUJÍAS CHAMPION SPARK CHAMPION CANDELE CHAMPION



Potencia HP  
Power HP  
Potenza HP

Año  
Year  
Anno

Ref

2 Tiempos / Stroke / Tempi

DT2	1977-96	CHAL90C
DT2.2	1997+	CHAL90C
DT3.5	1979-84	CHAQL87YC/L87YC
DT4	1985-98	CHAQL87YC/L87YC
DT4.5	1977+	CHAQL86C/L86C
DT5	1978-83	CHAQL87YC/L87YC
DT5Y	1999-01	CHAQL82YC/L82YC
DT6	1984-97	CHAQL87YC/L87YC
DT6	1998-01	CHAQL87YC/L87YC
DT7.5	1977-79	CHAQL86C/L86C
DT8	1980-87	CHAQL87YC
DT9	1977-79	CHAQL86C/L86C
DT9	1993	CHAQL86C/L86C
DT9.9C	1983-97	CHAQL82C/L82C
DT15	1983-88	CHAQL86C
DT15C	1989-97	CHAQL82C
T16	1977-82	CHAQL86C/L86C
DT20	1977-88	CHAQL82C/L82C
DT25C	1977-00	CHAQL82C/L82C
DT30C	1989+	CHAQL82C/L82C
DT35	1989+	CHAQL82C/L82C
DT40	1980-98	CHAQL78C/L78C
DT50	1997-84	CHAQL78C/L78C
DT55	1985-97	CHAQL78C/L78C
DT60	1983-84	CHAQL78C/L78C
DT65	1978-97	CHAQL78C/L78C
DT75	1983-97	CHAQL78C/L78C
DT85	1979-97	CHAQL78C/L78C
DT85	1998+	CHAQL78C/L78C
DT90 V4	1989-97	CHAQL78C/L78C
DT100 V4	1989-01	CHAQL78C/L78C
DT115 Carb	1981-97	CHAQL78C/L78C
DT115 EFI	1996-01	CHAQL78C/L78C
DT115S EFI	1998+	CHAQL78C/L78C
DT140 Carb	1981-96	CHAQL78C/L78C
DT140 EFI	1997-01	CHAQL78C/L78C
DT150 V6 EFI	1986-94	CHAQL78C/L78C
DT175 V6	1991-93	CHAQL78C/L78C
DT200 EFI	1986+	CHAQL78C/L78C
DT225 EFI	1991+	CHAQL78C/L78C



4 Tiempos / Stroke / Tempi

DF4	2003-04	CHARN9YC
DF6	2003-04	CHARN9YC
DF9.9	1997-04	CHARA8HC
DF15	1997-04	CHARA8HC
DF25	2000-04	CHARA8HC
DF30	2000-04	CHARA8HC
DF40	1999-04	CHARA8HC
DF50	1999-04	CHARA8HC
DF60	1998-04	CHARN9YC
DF70	1998-04	CHARN9YC
DF90	2001-04	CHARC9YC
DF115	2001-04	CHARC9YC
DF140	2002-04	CHARC9YC

# BUJÍAS NGK SPARK NGK CANDELE NGK



Potencia HP  
Power HP  
Potenza HP

Año  
Year  
Anno

Ref NGK

REF. NGK IRIIDIUM

2 Tiempos / Stroke / Tempi

DT2	1986-90	NGKBR4HS
DT2	1991-99	NGKBR5HS
DT2.2	1992+	NGKBR5HS
DT4	1988-92	NGKBP5HS
DT4	1993-01	NGKBPR5HS
DT4,5		NGKBR6HS
DT4L/S	1994+	NGKBPR5HS
DT4L/S	-1993	NGKBP5HS
DT5	1986-92	NGKBP6HS
DT5	1993-94	NGKBPR6HS
DT5	1995-00	NGKBR6HS
DT5W	1986-92	NGKBR6HS
DT5Y	1998-01	NGKBPR7HS-10
DT6	1986-92	NGKB6HS-10
DT6	1993-02	NGKBR6HS
DT6	-1985	NGKB6HS
DT6	1995-99	NGKBR6HS-10
DT6S/5PS	-1992	NGKB6HS
DT7.5		NGKBR6HS
DT8	1986-02	NGKBPR6HS
DT8C	1988-97	NGKBR6HS-10
DT9		NGKB6HS-10
DT9.9	1986-99	NGKBR7HS-10
DT9.9	1977-78	NGKB7HS
DT9.9	1879-84	NGKBR6HS
DT9.9	1976	NGKB6HS
DT9.9C	1988-97	NGKBR6HS-10
DT9.9E	1982+	NGKB6HS
DT9.9E	1984+	NGKB7HS
DT9.9E	1983+	NGKBR7HS-10
DT9.9K	1985-86	NGKB6HS
DT9.9K	-1985	NGKBR6HS
DT9.9K	1986-90	NGKB6HS
DT9.9P	-1983	NGKBPR6HS
DT15	1986-02	NGKBR7HS-10
DT15C	1989-97	NGKBR7HS-10
DT15K	-1985	NGKBR6HS
DT15K	1986+	NGKB6HS
DT20	1997-00	NGKBR7HS-10
DT20/P	-1985	NGKBR7HS
DT20/P	1986+	NGKBR7HS-10
DT20K	-1985	NGKBR7HS-10
DT20K	1986-87	NGKB7HS-10
DT25	-1985	NGKBR7HS
DT25	2000-01	NGKBR7HS-10
DT25C	1989-97	NGKBR7HS-10
DT25E	1983-85	NGKBPR7HS-10
DT25E	-1982	NGKB7HS
DT25E	1986+	NGKBR7HS-10
DT25K	1986+	NGKBR7HS-10
DT28P/DT28/DT28E		NGKB7HS
DT30	1986+	NGKBR7HS-10
DT30	1983-85	NGKBR7HS-10
DT30C	1988-00	NGKBR7HS-10
DT30E	1983+	NGKBR7HS-10
DT40	-1983	NGKB8HS
DT40C	1986-99	NGKB8HS-10
DT40C/CR/TC	1998+	NGKB8HS-10
DT40W	1995+	NGKB7HS-10



Potencia HP Power HP Potenza HP	Año Year Anno	Ref NGK	REF. NGK IRIIDIUM
DT40WK	1998+	NGKB7HS-10	
DT40WK	-1997	NGKB7HS	
DT48M	2001+	NGKB8HS-10	
DT48M	-2000	NGKB8HS	NGKBR8HIX
DT50	1979-83	NGKB8HS	NGKBR8HIX
DT50	-1978	NGKB7HS	
DT50	1984-89	NGKB8HS-10	
DT50ACR	1994-96	NGKB8HS-10	
DT50ACR	1993	NGKBR8HS	NGKBR8HIX
DT50C	1984-00	NGKB8HS-10	
DT50K		NGKB7HS	
DT50M/DT50	1986-89	NGKB8HS-10	
DT50M/DT50	-1985	NGKB8HS	NGKBR8HIX
DT50M/DT50	2001+	NGKBR8HS-10	
DT55C	1988-98	NGKBR8HS-10	
DT55M/MQ	-2000	NGKB8HS	NGKBR8HIX
DT55M/MQ	2001+	NGKBR8HS-10	
DT55TC/CRQ	1998+	NGKBR8HS-10	
DT60		NGKB8HS-10	
DT60C	2001+	NGKBR8HS-10	
DT60C	1986-87	NGKB8HS-10	
DT65/T	-1983	NGKBR8HS	NGKBR8HIX
DT65C	1988-99	NGKBR8HS-10	
DT65TC	1994-95	NGKBR8HS-10	
DT75/85	1990-92	NGKB8HS	NGKBR8HIX
DT75/85	1993-00	NGKBR8HS-10	
DT75C	2001+	NGKBR8HS-10	
DT75C	1993-00	NGKB8HS	NGKBR8HIX
DT75M	2001+	NGKBR8HS-10	
DT75M	-2000	NGKBR8HS	NGKBR8HIX
DT75TC	-2000	NGKB8HS	NGKBR8HIX
DT75TC	2001+	NGKBR8HS-10	
DT85	-1992	NGKBR8HS	NGKBR8HIX
DT85C	2001+	NGKBR8HS-10	
DT85C	1993-00	NGKBR8HS	NGKBR8HIX
DT85C	-1992	NGKBR8HS	NGKBR8HIX
DT85M	2001+	NGKBR8HS-10	
DT85M	-2000	NGKBR8HS	NGKBR8HIX
DT85MQ	1995-96	NGKB8HS-10	
DT85Q	2001+	NGKBR8HS-10	
DT85Q	-2000	NGKBR8HS	NGKBR8HIX
DT85TC	-2000	NGKB8HS	NGKBR8HIX
DT85TC	2001+	NGKBR8HS-10	
DT85W	2001+	NGKB8HS-10	
DT85W	-2000	NGKBR8HS	NGKBR8HIX
DT85WT	2001+	NGKB8HS-10	
DT85WT	1995-96	NGKB8HS-10	
DT90	-2000	NGKBR8HCS-10	
DT90	2001+	NGKBR8HS-10	
DT90TC	1996-97	NGKBR8HS	NGKBR8HIX
DT90TC	-1995	NGKBR8HCS-10	
DT90TC	1998+	NGKBR8HS-10	
DT100	2001+	NGKBR8HS-10	
DT100	1996-00	NGKBR8HS-10	
DT100	1990-95	NGKBR8HCS-10	
DT100	2000	NGKBR8HCS-10	
DT100TC	-1995	NGKBR8HCS-10	
DT100TC	1998+	NGKBR8HS-10	
DT100TC	1996-97	NGKBR8HS	NGKBR8HIX
DT115	-1990	NGKB8HS	NGKBR8HIX
DT115	1992+	NGKBR8HCS-10	
DT115C	1991-93	NGKBR8HCS-10	
DT115C	-1990	NGKB8HS	NGKBR8HIX
DT115C	2001+	NGKBR8HS-10	
DT115S	1996+	NGKBR8HS-10	
DT115STC	1996+	NGKBR8HS-10	
DT115TC	-1988	NGKB8HS-10	
DT115TC		NGKBR8HCS-10	
DT115TC(EFI)		NGKBR8HS-10	
DT140	1992+	NGKBR8HCS-10	
DT1140	-1990	NGKB8HS	NGKBR8HIX
DT140 EFI	1996+	NGKBR8HS-10	
DT140C	1991-96	NGKBR8HCS-10	

Potencia HP Power HP Potenza HP	Año Year Anno	Ref NGK	REF. NGK IRIIDIUM
DT1140C	-1990	NGKB8HS	NGKBR8HIX
DT140C EFI	1997+	NGKBR8HCS-10	
DT140T	-2000	NGKBR8HCS-10	
DT140T	2001+	NGKBR8HS-10	
DT140TC	-2000	NGKBR8HCS-10	
DT140TC EFI		NGKBR8HS-10	
DT150	1987-02	NGKBR8HS-10	
DT150G		NGKBR8HS-10	
DT150S		NGKBR8HS-10	
DT150SS		NGKBR8HS-10	
DT150STC		NGKBR8HS-10	
DT150TC	1989+	NGKBR8HS-10	
DT150TC EFI		NGKBR8HS-10	
DT175	1989-02	NGKBR8HS-10	
DT175TC	-1988	NGKB8HS-10	
DT175TC	1989+	NGKBR8HS-10	
DT200	1989-02	NGKBR8HS-10	
DT200G		NGKBR8HS-10	
DT200T		NGKBR8HS-10	
DT200TC	1989+	NGKBR8HS-10	
DT200V		NGKBR8HS-10	
DT225	1991-02	NGKBR8HS-10	
DT225TC		NGKBR8HS-10	
DT225TCL EFI		NGKBR8HS	NGKBR8HIX
<b>4 Tiempos / Stroke / Tempì</b>			
DF2.5	2006+	NGKCR6HS	
DF4	2002+	NGKBPR6ES	NGKBPR6EIX
DF5	2002+	NGKBPR6ES	NGKBPR6EIX
DF6	2002+	NGKBPR6ES	NGKBPR6EIX
DF8A	1995+	NGKCR6E	
DF9.9A	1995+	NGKCR6E	
DF15A	1995+	NGKCPR6EA-9	
DF20A	2000+	NGKCPR6EA-9	
DF25	2000+	NGKBKR6E	NGKBKR6EIX
DF30	2000+	NGKDCPR6E	NGKDCPR6EIX
DF40	1999+	NGKDCPR6E	NGKDCPR6EIX
DF50	1999+	NGKDCPR6E	NGKDCPR6EIX
DF40A	2011+	NGKDCPR6E	NGKDCPR6EIX
DF50A	2011+	NGKDCPR6E	NGKDCPR6EIX
DF60	1998-2011	NGKDCPR6E	NGKBPR6EIX
DF60A	2011+	NGKDCPR6E	NGKDCPR6EIX
DF70	1992-2011	NGKBPR6ES	NGKBPR6EIX
DF70A	2011+	NGKDCPR6E	NGKDCPR6EIX
DF80A	2011+	NGKDCPR6E	NGKDCPR6EIX
DF90	1998+	NGHBKR6E	NGKBKR6EIX
DF90A	2011+	NGKDCPR6E	NGKDCPR6EIX
DF100	2000+	NGKBKR6E	NGKBKR6EIX
DF100A	2000+	NGKBKR6E	NGKBKR6EIX
DF115	2000+	NGKBKR6E	NGKBKR6EIX
DF115A	2011+	NGKBKR6E	NGKBKR6EIX
DF140	2002+	NGKBKR6E	NGKBKR6EIX
DF140A	2011+	NGKBKR6E	NGKBKR6EIX
DF150	2006+	NGKBKR6E	NGKBKR6EIX
DF175	2006+	NGKBKR6E	NGKBKR6EIX
DF200	2004+	NGKBKR6E	NGKBKR6EIX
DF225	2004+	NGKBKR6E	NGKBKR6EIX
DF250	2004+	NGKBKR6E	NGKBKR6EIX
DF300	2007+	NGKBKR6E	NGKBKR6EIX





# BLOQUE MOTOR ENGINE BLOCK BLOCCO MOTORE

RECMAR®

2  
TIEMPOS  
STROKES

DT40C-W-G-X (1986-99)  
DTW-K1-KA (2001-04)

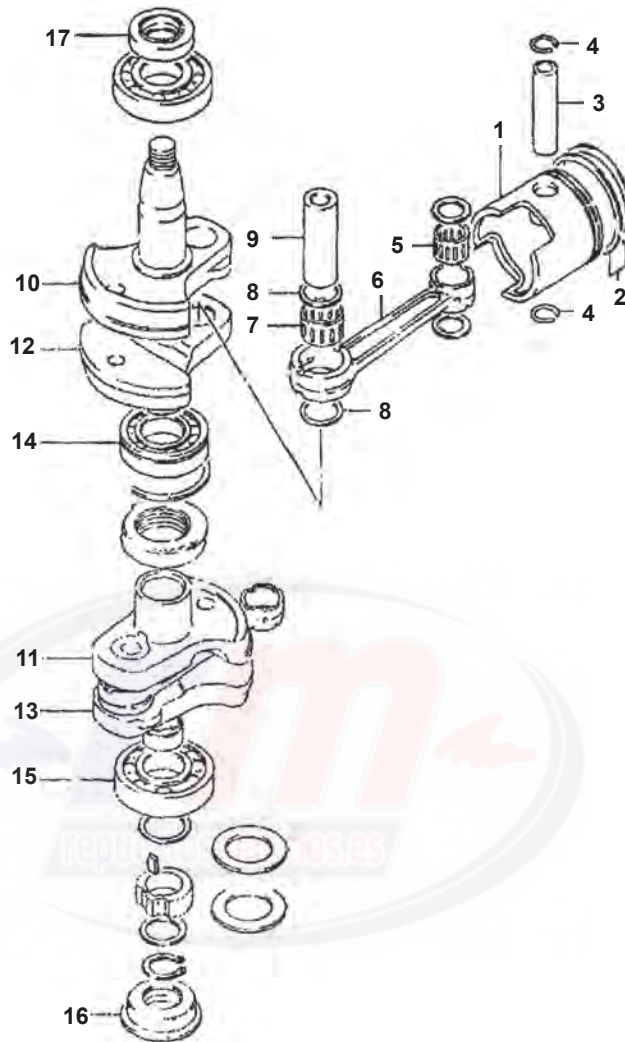

Nº	R.O. OEM	Ref.	Descripción	Description	Descrizione	Cantidad Quantity Quantità
1		REC12110-94400	PISTÓN	PISTON	PISTONE	2
2		REC12140-94400	SEGMENTO	RING SET, PISTON	SET FASCE	2
3		REC12151-94400	PIN	PIN, PISTÓN	SPINA, PISTONE	2
4		REC09381-20003	CLIP	SNAP RING	CLIP	4
5		REC09263-20072	RODAMIENTO	BEARING	CUSCINETTO	2
6		REC12161-94400	BIELA	CONNECTING ROD	BIELLA	2
7		REC09263-27005	RODAMIENTO	BEARING, CRANK PIN	CUSCINETTO	2
8		REC09160-27008	ARANDELA	WASHER	DONDELLA	4
9		REC12211-94410	PIN CIGÜEÑAL	PIN, CRANK	SPINOTTO ALBERO MOTORE	2
10		REC12221-94412	CIGÜEÑAL, SUP.	CRANKSHAFT, UPPER	ALBERO MOTORE, SUP.	1
11		REC12232-94412	CIGÜEÑAL, CENTRAL-INFERIOR	WHEEL, CRANKSHAFT, UNDER	ALBERO MOTORE, MED-INF	1
12		REC12231-94413	CIGÜEÑAL, CENTRAL-SUPERIOR	WHEEL, CRANKSHAFT, UPPER	ALBERO MOTORE, MED-SUP	1
13		REC12240-94432	CIGÜEÑAL, INF	CRANKSHAFT, UNDER	ALBERO MOTORE, INF.	1
14		REC09269-30012	RODAMIENTO, MEDIO	BEARING, MIDDLE	CUSCINETTO, MED.	1
15		REC09262-35052	RODAMIENTO INF.	BEARING, UNDER	CUSCINETTO, INF.	1
16		REC09283-30062	RETÉN	OIL SEAL	PARAOLIO	1
17		REC09283-35043	RETÉN	OIL SEAL	PARAOLIO	1

## PISTONES PISTONS PISTONI

Ref.	R.O.		
REC12110-93130K	12110-93130	Kit Pistón/ Piston kit/ Kit Pistoni	STD
REC12151-931000	12151-93100	Bulón / Pin / Bulone	
REC12140-93121	12140-93121	Aros / Rings / Fasce	STD
REC09263-14014	09263-14014	Rodamientos / Bearing / cuscinetto	
REC09381-14001	09381-14001	Clip	

### MOTORES / ENGINES / MOTORI

DT99/DT15K-G-Y (1986-00)  
DT9.9 / DT15K1-K4 (2001-04)



Ref.	R.O.		
REC12110-94350K		Kit Pistón/ Piston kit/ Kit Pistoni	STD
REC09381-18002	09381-18002	Clip	

### MOTORES / ENGINES / MOTORI

DT35 (1980-1982)  
DT40 (1980-1982)



Ref.	R.O.		
REC12110-94400K		Kit Pistón/ Piston kit/ Kit Pistoni	STD
REC12151-94400	12151-94400	Bulón / Pin / Bulone	
REC12140-94400	12140-94400	Aros / Rings / Fasce	STD
REC09263-20072	09263-20072	Rodamientos / Bearing / cuscinetto	
REC09381-20003	09381-20003	Clip	

### MOTORES / ENGINES / MOTORI

DT40C-W-G-X (1986-99)  
DT40W-K1-K4 (2001-04)



## BIELAS CONNECTING ROD BIELLA

Ref.	R.O.
REC12161-93902	12161-93902

### MOTORES / ENGINES / MOTORI

DT9.9K / DT15K-G-Y (1986-00)  
DT9.9 / DT15K1-K4 (2001-04)  
DT15C (1989-97)

Ref.	R.O.
REC12161-96300	12161-96300

### MOTORES / ENGINES / MOTORI

DT20 / DT25 / DT30G-Y (1986-00)  
DT25 / DT30K1-K2 (2001-02)

Ref.	R.O.
REC12161-94400	12161-94400

### MOTORES / ENGINES / MOTORI

DT40C-W-G-Y (1986-99)  
DT40WK1-K4 (2001-04)  
DT55 / DT65J-X (1988-99)



## RODAMIENTOS BEARING CUSCINETTI

### PIE / FOOT / PIEDE

Ref.	R.O.
REC09263-20051	09263-20051

### MOTORES / ENGINES / MOTORI

DT15C (1989-97)  
DT9.9 / DT15K1-K4 (2001-04)  
DT9.9K / DT15K-G-Y (1986-00)



Ref.	R.O.
REC09263-27005	09263-27005

### MOTORES / ENGINES / MOTORI

DT40C-W-G-X (1986-99)  
DT40W K1-K4 (2001-04)  
DT55 / DT65J-X (1988-99)



### CABEZA / HEAD / TESTA

Ref.	R.O.
REC09263-14022	09263-14022

### MOTORES / ENGINES / MOTORI

DT9.9K / DT15K G-Y (1986-00)  
DT9.9 / DT15K1-K4 (2001-04)



Ref.	R.O.
REC09263-18016	09263-14022

### MOTORES / ENGINES / MOTORI

DT25 (1983-88)  
DT30 (1983-88)



Ref.	R.O.
REC09263-20072	09263-20072

### MOTORES / ENGINES / MOTORI

DT40C-W-G-X (1986-99)  
DT40W K1-K4 (2001-04)  
DT55 / DT65J-X (1988-99)  
DT90 / DT100L-Y (1990-00)



Ref.	R.O.
REC09263-24018	09263-24018

### MOTORES / ENGINES / MOTORI

DF20 (1986-88)  
DT25 (1983-88)  
DT30 (1983-85)  
DT40 (1984-85)  
DT50 (1984+)



## ARANDELAS THRUST WASHER RONDELLA

Ref.	R.O.
REC09160-27008	09160-27008

### MOTORES / ENGINES / MOTORI

DT35 (1987-89) DT55 (1985-97)  
DT40 (1986-98) DT65 (1985-97)



Ref.	R.O.
REC09181-24001	09181-24001

### MOTORES / ENGINES / MOTORI

DT20 / DT25 / DT30G-Y (1986-00)  
DT25 / DT30K1-K2 (2001-02)



Ref.	R.O.
REC09160-20052	09160-20052

### MOTORES / ENGINES / MOTORI

DT15C (1989-97)  
DT9.9 / DT15K1-K4 (2001-04)  
DT9.9K / DT15K-G-Y (1986-00)





# CIGÜEÑAL CRANKSHAFT ALBERO MOTORE

## CIGÜEÑAL SUPERIOR CRANKSHFT UPPER ALBERO MOTORE SUPERIORE

Ref.	R.O.
REC12221-94412	12221-94412

### MOTORES / ENGINES / MOTORI

DT40C-W-G-X (1986-99)  
DTW-K1-K4 (2001-04)



## CIGÜEÑAL CENTRAL - SUPERIOR WHEEL, CRANKSHFT UPPER ALBERO MOTORE CENTRALE SUPERIORE

Ref.	R.O.
REC12231-94413	12231-94413

### MOTORES / ENGINES / MOTORI

DT40C-W-G-X (1986-99)  
DTW-K1-K4 (2001-04)



## CIGÜEÑAL CENTRAL - INFERIOR WHEEL, CRANKSHFT UNDER ALBERO MOTORE CENTRALE INFERIORE

Ref.	R.O.
REC12232-94412	12232-94412

### MOTORES / ENGINES / MOTORI

DT40C-W-G-X (1986-99)  
DTW-K1-K4 (2001-04)



## CIGÜEÑAL INFERIOR CRANKSHFT UNDER ALBERO MOTORE INFERIORE

Ref.	R.O.
REC12240-94432	12240-94432

### MOTORES / ENGINES / MOTORI

DT40C-W-G-X (1986-99)  
DTW-K1-K4 (2001-04)



## RODAMIENTOS CIGÜEÑAL BEARING CRANKSHAFT CUSCINETTI ALBERO MOTORE

Ref.	R.O.
REC09262-25078	09262-25078

### MOTORES / ENGINES / MOTORI

DT9.9K / DT15K-G-Y (1986-00)  
DT9.9/DT15K1-K4 (2001-04)

25 x 25 x 15 mm



Ref.	R.O.
REC09262-30055	09262-30055

### MOTORES / ENGINES / MOTORI

DT20/DT25/DT30G-Y (1986-00)  
DT25 / DT30K1-K2 (2001-04)  
DT75 / DT85J-Y (1988-00)

30 x 72 x 19 mm



Ref.	R.O.
REC09269-30012	09269-30012

### MOTORES / ENGINES / MOTORI

DT40X-W-G-X (1986-99)  
DT40WK1-K4 (2001-04)  
DT55 / DT65J-X (1988-99)  
DT75 / DT85J-Y (1988-00)

30 x 72 x 19 mm

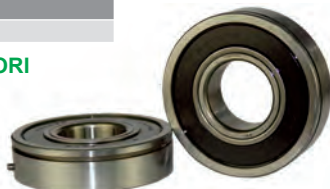

# JUNTA DE CULATA GASKET CYLINDER HEAD GUARNIZIONE TESTATA



## JUNTA DE CULATA GASKET CYLINDER HEAD GUARNIZIONE TESTATA

Ref.	R.O.
REC11141-98401	11141-98411

### MOTORES / ENGINES / MOTORI

DT2 / DT2.2 G-Y (1686-00)



Ref.	R.O.
REC11141-98130	11141-98130

### MOTORES / ENGINES / MOTORI

DT5 / DT6 / DT8G-Y (1986-00)  
DT6 / DT8Y-KS (2000-02)



Ref.	R.O.
REC11141-92D20	11141-92D20

### MOTORES / ENGINES / MOTORI

DT8 / DT9.9C-J-V (1988-97)



Ref.	R.O.
REC11141-93960	11141-93950

### MOTORES / ENGINES / MOTORI

DT9.9D / DT15K-G-Y (1986-00)  
DT9.9 / DT15K1-K4 (2001-04)  
DT15C (1989-97)



Ref.	R.O.
REC11141-96303	11141-96344

### MOTORES / ENGINES / MOTORI

DT20 / DT25 / DT30G-Y (1986-00)



Ref.	R.O.
REC11141-95D40	11141-95D40

### MOTORES / ENGINES / MOTORI

DT25C / DT30C-K-Y (1989-00)



Ref.	R.O.
REC11141-96344	11141-96343

### MOTORES / ENGINES / MOTORI

DT25 / DT30 K1-K2 (2001-02)



Ref.	R.O.
REC11141-94450	11141-94450

### MOTORES / ENGINES / MOTORI

DT40C-W-G-X (1986-99)



Ref.	R.O.
GLM36250	11141-94701/94720

### MOTORES / ENGINES / MOTORI

DT55 / DT65J-X (1988-99)



Ref.	R.O.
GLM36260	11141-95505/95621

### MOTORES / ENGINES / MOTORI

DT75 / DT85J-Y (1988-00)



Ref. R.O.  
GLM36230 11141-94506/94620

**MOTORES / ENGINES / MOTORI**  
DT115 / DT140G-Y (1986-00)  
4 Inline



Ref. R.O.  
GLM36220 11141-87D90/87E20

**MOTORES / ENGINES / MOTORI**  
DT90 / DT100L-Y (1999-00)  
V4



Ref. R.O.  
GLM36200 11141-87D90/87D61

**MOTORES / ENGINES / MOTORI**  
150/200 HP (1986)  
V6



Ref. R.O.  
GLM36210 11141-87D92/87D32

**MOTORES / ENGINES / MOTORI**  
V6H-Y (1987-00)  
DT150 / DT200 /  
DT225W-K3 (1998-03)



## JUNTA DE CULATA GASKET CYLINDER HEAD GUARNIZIONE TESTATA

Ref. R.O.  
REC11141-97J02 11141-97JL0

**MOTORES / ENGINES / MOTORI**  
DF2.5 (2006-15)



Ref. R.O.  
REC11141-93E20 11141-93E20

**MOTORES / ENGINES / MOTORI**  
DF9.9 / DF15T-K3 (1996-03)  
DF9.9 / DF15 (R) (2004-11)



Ref. R.O.  
REC11141-95J00 11141-95J00

**MOTORES / ENGINES / MOTORI**  
DF20 / DF25 / DF25R V2 (2006-11)



Ref. R.O.  
REC11141-90J01 11141-90J00

**MOTORES / ENGINES / MOTORI**  
DF90 / DF100 / DF115K1-K11 (2001-2011)

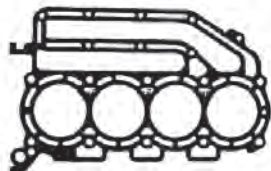

Ref. R.O.  
REC11141-92J01 11141-92J00

**MOTORES / ENGINES / MOTORI**  
MODELOS A / A MODELS / MODELLO A  
DF100A / DF115A / DF140A (2013+)  
DF140 (2002-12)

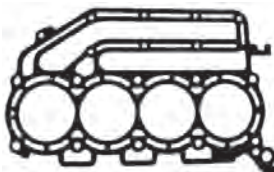

Ref. R.O.  
REC11141-93J10 11141-93J03 STB

**MOTORES / ENGINES / MOTORI**  
DF200 / DF225 / DF250 (2004+)



Ref. R.O.  
REC11142-93J10 11142-93J03 PORT

**MOTORES / ENGINES / MOTORI**  
DF200 / DF225 / DF250 (2004+)



Ref. R.O.  
REC11141-98J10 11141-98J01 STB

**MOTORES / ENGINES / MOTORI**  
DF300AP (2012)  
DF300T-Z (2007-11)



Ref. R.O.  
REC11142-98J10 11142-98J00 PORT

**MOTORES / ENGINES / MOTORI**  
DF300AP (2012)  
DF300T-Z (2007-11)

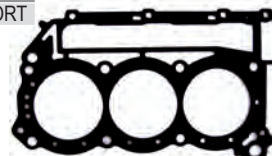

## GUÍA JUNTAS CULATA GASKET CYLINDER HEAD GUIDA GUARNIZIONE TESTATA

MODELO MODEL MODELLO	AÑO YEAR ANNO	R.O. OEM	REF
DT2.2/DT2.2 G-Y	1986-00	11141-98411	REC11141-98401
DT5/DT6/DT8 G-Y	1986-00	11141-98130	REC11181-98130
DT6/DT8 Y-K2	2000-02	11141-98130	REC11181-98130
DT8/DT9.9 C-J-V	1998-97	11141-92D20	REC11141-92D20
DT9.9K/DT15 K-G-Y	1986-00	11141-93950	REC11141-93960
DT9.9/DT15 K1-K4	2001-04	11141-93950	REC11141-93960
DT15C	1989-97	11141-93950	REC11141-93960
DT20/DT25/DT30 G-Y	1986-00	11141-96344	REC11141-96303
DT25-DT30 C-K-Y	1989-00	11141-95D40	REC11141-95D40
DT25/DT30 K1-K2	2001-01	11141-96343	REC11141-96344
DT40 C-W-G-X	1986-99	11141-94440	REC11141-94450
DT55/DT65 J-X	1988-99	11141-94720	GLM36250
DT75/DT85 J-Y	1988-00	11141-95621	GLM36260
DT90/DT100 L-Y	1990-00	11141-87E20	GLM36220
DT115/DT140 G-Y	1986-00	11141-94620	GLM36230
DT150/DT200 V6	1986-86	11141-87D61	GLM36200
DT150/DT200/DT225 W-K3	1998-03	11141-87D32	GLM36210
DF2.5	2006-15	11141-97JL0	REC11141-97J02
DF9.9/DF15 T-K3	1996-03	11141-93E20	REC1114193E20
DF9.9/DF15 R	2004-11	11141-93E20	REC1114193E20
DF20/DF25 R-V2	2006-11	11141-95J00	REC11141-95J00
DF90/DF100/DF115 K1-K11	2001-11	11141-90J01	REC11141-90J01
DF100A/DF115A/DF140A	2013 +	11141-92J00	REC11141-92J01
DF140	2002-12	11141-92J00	REC11141-92J01
DF200/DF225/DF250 V6 (STB)	2004 +	11141-93J03	REC11141-93J10
DF200/DF225/DF250 V6 (PORT)	2004 +	11142-93J03	REC11142-93J10
DF300 T/Z V6 (STB)	2007-11	11141-98J01	REC11141-98J10
DF300 T/Z V6 (PORT)	2007-11	11142-98J00	REC11141-98J10
DF300 AP V6 (STB)	2012-12	11141-98J01	REC11141-98J10
DF300 AP V6 (PORT)	2012-12	11142-98J00	REC11141-98J10

## JUNTAS CULATÍN GASKET, HEAD COVER GUARNIZIONE COPERCHIO TESTA

Ref. R.O.  
REC11162-94410 11162-94410

**MOTORES / ENGINES / MOTORI**  
DT40C-WG-X (1986-99)  
DT40W K1-K4 (2001-04)

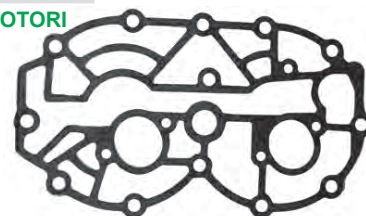



## JUNTAS CARTER OIL PAN GASKET GUARNIZIONE CARTER

Ref.	R.O.
REC11489-90J00	11489-90J00

**MOTORES / ENGINES / MOTORI**  
DF90 / DF100 / DF115 K1-K11 (2001-11)  
DF140 (2002-12)  
DF115WT / DF140WT-K3 (2003)  
DF100A / DF115A 7 / DF140 (2013+)

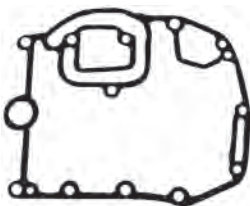

Ref.	R.O.
REC11489-93E11	11489-93E10

**MOTORES / ENGINES / MOTORI**  
DF9.9 / DF15 (R) (2004-11)  
DF15 (2012)



Ref.	R.O.
REC11489-93J00	11489-93J00

**MOTORES / ENGINES / MOTORI**  
DF200 / DF225 / DF250 (2004+)  
DF300AP (2012)  
DF300T-Z (2007-11)

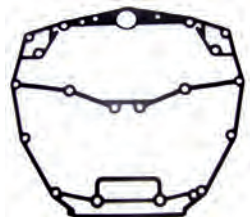

## JUNTAS BASE GASKET, UNDER OIL GUARNIZIONE BASE OLIO

Ref.	R.O.
REC11433-93912	11433-93901

**MOTORES / ENGINES / MOTORI**  
DT9.9 / DT15 K1-K4 (2001-04)  
DT9.9K / DT15K-G-Y (1986-00)

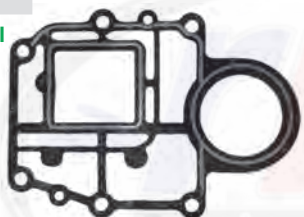

Ref.	R.O.
REC11433-94412	11433-94412

**MOTORES / ENGINES / MOTORI**  
DT40C-W-G-X (1986-00)

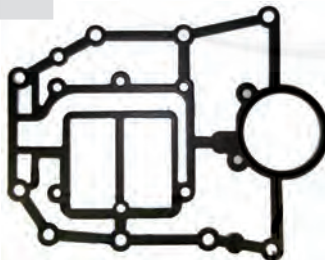

Ref.	R.O.
REC11433-96330	11433-96302

**MOTORES / ENGINES / MOTORI**  
DT20 / DT25 / DT30G-Y (1986-00)  
DT25 / DT30 K1-K2 (2001-02)

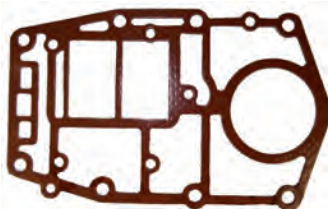

Ref.	R.O.
REC51142-93J00	51142-93J00

**MOTORES / ENGINES / MOTORI**  
DF200 / DF225 / DF250 (2004+)  
DF300AP (2012)  
DF300T-Z (2007-11)



## JUNTAS BASE MOTOR GASKET, ENGINE HOLDER GUARNIZIONE, BASE MOTORE

Ref.	R.O.
REC51211-90J10	51211-90J22

**MOTORES / ENGINES / MOTORI**  
DF90 / DF100 / DF115 K1-K11 (2001-11)  
DF140 (2002-12)



Ref.	R.O.
REC51211-93J00	51211-93J00

**MOTORES / ENGINES / MOTORI**  
DF200 / DF225 / DF250 (2004-15)  
DF300AP (2012)  
DF300T/Z (2007-11)

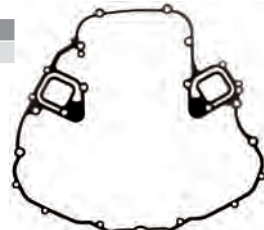

## JUNTAS COLECTOR GASKET, COLLECTOR GUARNIZIONE COLLECTTORE

**JUNTA TAPA COLECTOR  
GASKET, COLLECTOR COVER  
GUARNIZIONE, TAPPO COLLECTTORE**

Ref.	R.O.
REC13147-98J00	13147-98J00

**MOTORES / ENGINES / MOTORI**  
DF300AP (2012)  
DF300T/Z (2007-11)

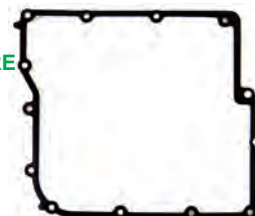

**JUNTA COLECTOR ADMISIÓN  
GASKET, INTAKE MANIFOLD  
GUARNIZIONE, COLLETTORE DI ASPIRAZIONE**

Ref.	R.O.
REC13119-93J00	13119-93J00

**MOTORES / ENGINES / MOTORI**  
DF200 / DF225 / DF250 (2004+)



Ref.	R.O.
REC13122-95J00	13122-95J00

**MOTORES / ENGINES / MOTORI**  
DF20R / DF25 / DF25R V2 (2006 -11)



## JUNTAS, BASE RETÉN GASKET, MOUNT OIL SEAL COVER GUARNIZIONE, BASE PARAOLIO

Ref.	R.O.
REC51123-93J00	51123-93J00

**MOTORES / ENGINES / MOTORI**  
DF200 / DF225 / DF250 (2004+)  
DF300AP (2012)  
DF300T/Z (2007-11)

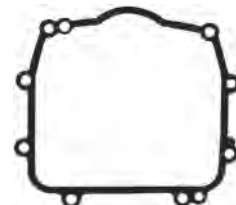

## JUNTA, GUÍA CADENA GASKET TIMING CHAIN GUIDE BASE GUARNIZIONE CARTER CATENA GUIDA BASE

Ref.	R.O.
REC12778-93J00	12778-93J00

**MOTORES / ENGINES / MOTORI**  
DF200 / DF225 / DF250 (2004+)  
DF300AP (2012)  
DF300T/Z (2007-11)



## JUNTAS GASKET OIL GALLERY GUARNIZIONE OLIO

Ref.	R.O.
REC16433-93J00	16433-93J00

**MOTORES / ENGINES / MOTORI**  
DF200 / DF225 / DF250 (2004+)  
DF300AP (2012)  
DF300T/Z (2007-11)



Ref.	R.O.
REC17693-95J00	17693-95J00

**MOTORES / ENGINES / MOTORI**  
DF20R / DF25 / DF25R V2 (2006-11)



## JUNTA, CUERPO MARIPOSA GASKET, THROTTLE BODY GUARNIZIONI, CORPO FARFALLATO

Ref.	R.O.
REC13421-98J00	13421-98J00

**MOTORES / ENGINES / MOTORI**  
DF300AP (2012)  
DF300T/Z (2007-11)



## JUNTAS ESCAPE EXHAUST GASKET GUARNIZIONE SCARICO

Ref.	R.O.
REC14212-94413	14212-94412

**MOTORES / ENGINES / MOTORI**  
DT40C-W-G-X (1986-99)



Ref.	R.O.
REC52113-96330	52113-96304

**MOTORES / ENGINES / MOTORI**  
DT20 / DT25 / DT30G-Y (1986-00)  
DT25 / DT30K1-K4 (2001-02)

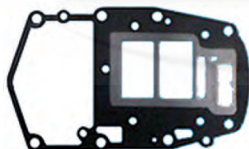

Ref.	R.O.
REC52113-93910	52113-93901

**MOTORES / ENGINES / MOTORI**  
DT9.9 / DT15 K1-K4 (2001-04)  
DT9.9K / DT15K-G-Y (1986-00)

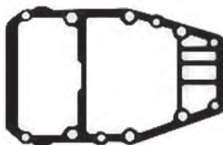

Ref.	R.O.
REC14151-96311	14151-96310

**MOTORES / ENGINES / MOTORI**  
DT20 / DT25 / DT30G-Y (1986-00)  
DT25 / DT30 K1-K2 (2001-02)



Ref.	R.O.
REC11434-94411	11434-94411

**MOTORES / ENGINES / MOTORI**  
DT40C-W-G-X (1986-99)  
DT40W K1-K4 (2001-04)

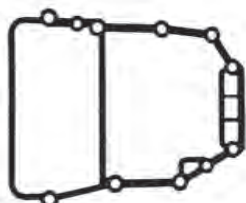

Ref.	R.O.
REC14151-93912	14151-93901

**MOTORES / ENGINES / MOTORI**  
DT9.9 / DT15 K1-K4 (2001-04)  
DT9.9K / DT15K-G-Y (1986-00)

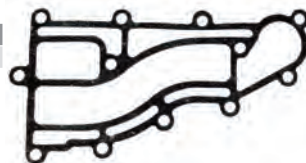

Ref.	R.O.
REC14151-94411	14151-94412

**MOTORES / ENGINES / MOTORI**  
DT40C-W-G-X (1986-99)  
DT40W K1-K4 (2001-04)

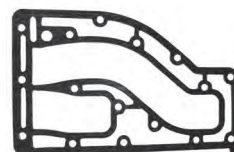

## JUNTA TUBO ESCAPE GASKET, EXHAUST TUBE GUARNIZIONE, TUBO DI SCARICO

Ref.	R.O.
REC14212-93J00	14212-93J00

**MOTORES / ENGINES / MOTORI**  
DF200 / DF225 / DF250 (2004+)  
DF300AP (2012)  
DF300T/Z (2007-11)



Ref.	R.O.
REC52331-87L00	52331-87L00

**MOTORES / ENGINES / MOTORI**  
DF70A / DF80A / DF90A (2009+)



## JUNTA TAPA ESCAPE GASKET, EXHAUST COVER GUARNIZIONE, COPERTURA SCARICO

Ref.	R.O.	
REC14152-93J00	14152-93J00	PORT
REC14151-93J00	14151-93J00	STB

**MOTORES / ENGINES / MOTORI**  
DF200 / DF225 / DF250 (2004+)  
DF300AP (2015)  
DF300T/Z (2007-11)



REC14151-93J00

REC14152-93J00

## RETENES ACEITE OIL SEALS PARAOLIO

Ref.	R.O.
REC09282-10008	09282-10008

**MOTORES / ENGINES / MOTORI**  
DF2.5 (2006-13)  
DF4 / DF5 / DF6 (2002+)  
DT4/J4 / DT5Y (1988-02)  
DT4K1 (2001)



10 x 21 x 4.5 mm

Ref.	R.O.
REC09282-12008	09282-12008

**MOTORES / ENGINES / MOTORI**  
DF2.5 (2012)  
DTK1 (2001)  
DF4 / DF5 / DF6 (2002-12)  
DT4 / J4 / DT5Y (1988-02)  
DT8 / DT9.9C-J-V (1988-97)



12 x 24 x 4.5 mm

Ref.	R.O.
REC09282-12010	09282-12010

**MOTORES / ENGINES / MOTORI**  
DF9.9 / DF15 (R) (2004-12)  
DF9.9 / DF15T-K3 (1996-03)  
DT15C (1989-97)  
DT9.9K / DT15K-G-Y (1986-00)  
DT9.9 / DT15K1-K4 (2001-04)



12 x 25 x 7 mm



Ref.	R.O.
REC09282-15008	09282-15008

**MOTORES / ENGINES / MOTORI**

DF20R / DF25 / DF25RVZ (2006-11)  
DT20 / DT25 / DT30G-Y (1986-00)  
DT25 / DT301-K2 (2001-02)

14.7 x 25 x 6.5 mm



Ref.	R.O.
REC09282-17005	09282-17005

**MOTORES / ENGINES / MOTORI**

DF40 / DF50X-K10 (1999-10)  
DF40A / DF50A / DF60A (2010+)  
DT40X-W-G-X (1986-99)  
DT40W-K1-K4 (2001-04)

17 x 32 x 6 mm



Ref.	R.O.
REC09282-17009	09282-17009

**MOTORES / ENGINES / MOTORI**

DF25 / DF30W-K6 (2000-06)  
DF40 / DF50Y-K10 (1999-10)  
DT25C / DT30C-K-Y (1989-00)  
DT40C-W-G-X (1986-99)  
DT40W-K1-K4 (2001-04)  
DT55 / DT65J-X (1988-99)

17 x 28 x 6 mm



Ref.	R.O.
REC09283-10003	09283-10003

**MOTORES / ENGINES / MOTORI**

DT4 / J4 / DT5Y (1988-02)  
DT4K1 (2001)  
DT5 / DT6 / DT8G-Y (1986-00)  
DT6 / DT8Y-K2 (2000-02)

10 x 22 x 6 mm



Ref.	R.O.
REC09283-10009	09283-10009

**MOTORES / ENGINES / MOTORI**

DF4 / DF5 / DF6 (2002+)

10 x 45 x 5 mm



Ref.	R.O.
REC09283-17002	09283-17002

**MOTORES / ENGINES / MOTORI**

DT2 / DT2.2G-Y (1986-00)  
DT2.2K1-K5 (2001-05)

17 x 29 x 7 mm



Ref.	R.O.
REC09283-20018	09283-20018

**MOTORES / ENGINES / MOTORI**

DT4K1 (2001)  
DT4 / J4 / DT5Y (1988-02)  
DT8 / DT9.9C-J-V (1988-97)  
DT15C (1989-97)

20 x 37 x 9 mm



Ref.	R.O.
REC09283-20045	09283-20045

**MOTORES / ENGINES / MOTORI**

DT4 -J4-DT5Y (1988-00)  
DT5Y (1998-02)  
DT4K1 (2001)



Ref.	R.O.
REC09283-25035	09283-25035

**MOTORES / ENGINES / MOTORI**

DT15C (1989-97)  
DT9.9K / DT15K-G-Y (1986-00)  
DT9.9 / DT15K1-K4 (2001-04)

25 x 40 x 7 mm



Ref.	R.O.
REC09283-25075	09283-25075

**MOTORES / ENGINES / MOTORI**

DT9.9K / DT15K-G-Y (1986-00)  
DT9.9 / DT15K1-K4 (2001-04)

25 x 52 x 7 mm



Ref.	R.O.
REC09283-25076	09283-25076

**MOTORES / ENGINES / MOTORI**

DF4 / DF5 / DF6 (2002+)

25 x 45 x 5 mm



Ref.	R.O.
REC09283-30062	09283-30062

**MOTORES / ENGINES / MOTORI**

DT20 / DT25 / DT30G-Y (1986-00)  
DT25 / DT30K1-K2 (2001-02)  
DT40C-W-G-X (1986-99)  
DT40W K1-K4 (2001-04)  
DT55 / DT65J-X (1988-99)  
DT75 / DT85Y (1988-00)

30 x 55 x 8 mm



Ref.	R.O.
REC09283-30064	09283-30064

**MOTORES / ENGINES / MOTORI**

DT20 / DT25 / DT30G-Y (1986-00)  
DT25 / DT30K1-K2 (2001-02)

30 x 55 x 10 mm



Ref.	R.O.
REC09283-35043	09283-35043

**MOTORES / ENGINES / MOTORI**

DT40C-W-G-X (1986-99)  
DT40WK1-K4 (2001-04)  
DT55 / DT65J-X (1988-99)

35 x 55 x 7 mm



Ref.	R.O.
REC09289-10005	09289-10005

**MOTORES / ENGINES / MOTORI**

DT2 / DT2.2G-Y (1986-00)  
DT2.2 K1-K5 (2001-05)



Ref.	R.O.
REC09289-12002	09289-12002

**MOTORES / ENGINES / MOTORI**

DT2 / DT2.2 G-Y (1986-00)  
DT2.2 K1-K5 (2001-05)

12 x 28 x 8 mm



Ref.	R.O.
REC09289-17004	09289-17004

**MOTORES / ENGINES / MOTORI**

DT20 / DT25 / DT30G-Y (1986-00)  
DT25 / DT30K1-K2 (2001-02)

17 x 30 x 9 mm



Ref.	R.O.
REC09289-17006	09289-17006

**MOTORES / ENGINES / MOTORI**

DF8A-AR / DF9.9A-AR (2010-12)  
DF9.9 / DF15(R) (2004-12)  
DF9.9 / DF15T-K3 (1996-03)  
D9.9K / DT15K-G-Y (1986-00)  
DT9.9 / DT15K1-K4 (2001-04)  
DT15C (1989-97)

17 x 30 x 6 mm



Ref.	R.O.
REC09289-20009	09289-20009

**MOTORES / ENGINES / MOTORI**

DF20R / DF25 / DF25RVZ (2006-11)  
DF25 / DF30Y-K6 (2000-06)  
DT20 / DT25 / DT30G-Y (1986-00)  
DT25 / DT30K1-K2 (2001-02)  
DT25C / DT30C-K-Y (1989-00)

20 x 34 x 6,5 mm



Ref.	R.O.
REC09289-22007	09289-22007

**MOTORES / ENGINES / MOTORI**

DF40A / DF50A / DF60A (2010+)  
 DF40 / DF50X-K10 (1999-10)  
 DT40X-W-G-X (1986-99)  
 DT40C-W-G-X (1986-99)  
 DT40W-K1-K4 (2001-04)  
 DT55 / DT65J-X (1988-99)

21.2 x 35 x 5 mm

Ref.	R.O.
REC09289-30008	09289-30008

**MOTORES / ENGINES / MOTORI**

DT9.9K / DT15K-G-Y (1986-00)  
 DT9.9 / DT15K1-K4 (2001-04)

30 x 52 x 10 mm



**KITS CARBURADOR  
 CARBURETOR KIT  
 GUIDA CARBURATORI**

Ref.	R.O.
REC13910-87D00	13910-87D00



Ref.	R.O.
REC13910-94701	13910-94701



Ref.	R.O.
REC13910-94400	13910-94400



Ref.	R.O.
REC13910-95D00	13910-95D00



Ref.	R.O.
REC13910-89J01	13910-89J01



MODELO MODEL MODELLO	AÑO YEAR ANNO	REF
DT25C / DT30C-K-Y	1989-00	REC13910-95D00
DF25 / DF30Y-K6	2000-06	REC13910-89J01
DT40C-W-G-X	1986-99	REC13910-94400
DT40W-K1-K4	2001-04	REC13910-94400
DT55 / DT65J-X	1988-99	REC13910-94701
DT75 / DT85J-Y	1988-00	REC13910-94701
DT115 / DT140G-Y	1986-00	REC13910-94701
DT90 / DT100L-Y	1990-00	REC13910-87D00
V6 H-Y	1987-00	REC13910-87D00

**BOMBA COMBUSTIBLE  
 FUEL PUMP ASSY  
 POMPA BENZINA**

Ref.	R.O.
REC15200-96J00	15200-96J00

**MOTORES / ENGINES / MOTORI**

DF150 / DF175T/Z (G) (2014)  
 DF150 / DF175T/Z (2006-13)  
 DF200A (2015)



**KIT MEMBRANAS BOMBA COMBUSTIBLE  
 DIAPHRAGM SET, FUEL PUMP  
 KIT MEMBRANA POMPA BENZINA**

Ref.	R.O.
REC15170-93911	15170-93920

**MOTORES / ENGINES / MOTORI**

DT9.9K / DT15K-G-Y (1986-00)  
 DT9.9 / DT15K1-K4 (2001-04)  
 DT8 / DT9.9C-J-V (1988-97)  
 DT15C (1989-97)



Ref.	R.O.
REC15170-94320	15170-94320

**MOTORES / ENGINES / MOTORI**

DT20 / DT25 / DT30G-Y (1986-00)  
 DT25 / DT30 K1-K2 (2001-02)  
 DT25C / DT30C K-Y (1989-00)  
 DT40C-W-G-X (1986-99)  
 DT40W-K1-K4 (2001-04)  
 DT55 / DT65J-X (1988-99)



Ref.	R.O.
REC15170-98110	15170-98110

**MOTORES / ENGINES / MOTORI**

DT4 / J4 / DT5Y (1988-00)  
 DT4 K1 (2001)  
 DT5Y (1998-02)  
 DT5 / DT6 / DT8G-Y (1986-00)  
 DT6 / DT8Y-K2 (2000-02)



Ref.	R.O.
REC15170-91J00	15170-91J00

**MOTORES / ENGINES / MOTORI**

DF4 / DF5 / DF6 (2002-11)



Ref.	R.O.
REC15170-94J00	15170-94J00

**MOTORES / ENGINES / MOTORI**

DF8A / DF8AR / DF9.9A / DF9.9AR (2010-11)  
 DF9.9 / DF15 (R) (2004-11)



Ref.	R.O.
REC15170-99E00	15170-99E00

**MOTORES / ENGINES / MOTORI**

DF9.9 / DF15R-K3 (1996-03)  
 DF25 / DF30Y K6 (2000-06)  
 DF40 / DF50Z-K10 (1999-10)  
 DF60 / DF70W-K9 (1998-09)





## GUÍA IMPULSORES / IMPELLER GUIDE / GUIDA GIRANTE

Todos los motores Suzuki utilizan impulsores de 6 palas. MEDIDAS mm (A-B-C)  
All Suzuki engines use 6 impellers blades. Measurements mm (A-B-C)  
Tutti i motori utilizzano giranti con 6 pale. Misure mm (A-B-C)

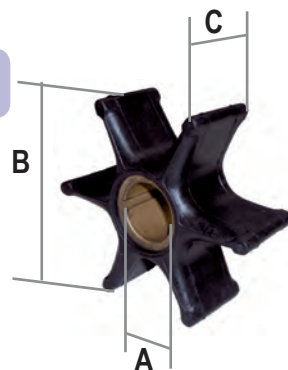

Modelo Model Modello	AÑO YEAR ANNO	R.O. OEM	Ref. RECMAR	Ref. CEF	Medidas / Measurements / Misure		
					A	B	C
DT4	1988-2001	17461-98501,2,3	REC17461-98503	CEF500336	10,15	41,00	14,00
DT5	1986-2002	17461-98501,2,3	REC17461-98503	CEF500336	10,15	41,00	14,00
DT6	1984-2002	17461-98501,2,3	REC17461-98503	CEF500336	10,15	41,00	14,00
DT8	1980-1987	17461-98501,2,3	REC17461-98503	CEF500336	10,15	41,00	14,00
DT8	1988-1997	17461-92D02	REC17461-92D02	CEF500319	12,20	42,00	20,00
DT9,9	1980-1987	17461-93001,3,4	REC17461-93004	CEF500398	15,00	70,00	12,50
DT9,9	1988-1997	17461-92D02	REC17461-92D02	CEF500319	12,20	42,00	20,00
DT14	1977-1980	17461-93001,3,4	REC17461-93004	CEF500398	15,00	70,00	12,50
DT15	1986-1997	17461-93901,2,3	REC17461-93903	CEF500329	13,20	42,00	22,00
DT16	1977-1982	17461-93001,2,3,4	REC17461-93004	CEF500398	15,00	70,00	12,50
DT20	1986-1988	17461-96301	REC17461-96312	CEF500362G	17,10	67,50	16,18
DT25	1977-1982	17461-93001,2,3,4	REC17461-93004	CEF500398	15,00	70,00	12,50
DT25	1983-1988	17461-96301	REC17461-96312	CEF500362G	17,10	67,50	16,18
DT25	1989-2000	17461-96400		CEF500399	17,20	67,00	16,16
DT28	1972-1982	17461-93002	REC17461-93004	CEF500398	15,00	70,00	12,50
DT30	1983-1985	17461-96301	REC17461-96312	CEF500362G	17,10	67,50	16,18
DT30	1989-2000	17461-96400		CEF500399	17,20	67,00	16,16
DT35	1987-1989	17461-96301	REC17461-96312	CEF500362G	17,10	67,50	16,18
DT40	1983	17461-95201		CEF500312	19,13	51,80	19,00
DT40	1984-1998	17461-96310	REC17461-96312	CEF500362G	17,10	67,50	16,18
DT50	1978-1984	17461-95501,95300	REC17461-95300	CEF500360	20,10	67,50	19,00
DT55	1985-1997	17461-94700,1	REC17461-94700	CEF500361	17,10	67,00	19,00
DT60	1983	17461-95200	REC17461-94700	CEF500361	17,10	67,00	19,00
DT60	1984	17451-96301	REC17461-96312	CEF500362G	17,10	67,50	16,18
DT65	1985-1997	17461-94701	REC17461-94700	CEF500361	17,10	67,00	19,00
DT75	1983-1997	17461-95501,95300,1,2	REC17461-95300	CEF500360	20,10	67,50	19,00
DT85	1983-2000	17461-95501,95300,1,2	REC17461-95300	CEF500360	20,10	67,50	19,00
DT90	1988++	17461-87E12	REC17461-87E12	CEF500365	22,20	78,30	35,10
DT100	1988++	17461-87E12	REC17461-87E12	CEF500365	22,20	78,30	35,10
DT115	1986-2001	17461-94510		CEF500367	24,30	86,00	31,70
DT140	1986-2001	17461-94510		CEF500367	24,30	86,00	31,70
DT150	1987-1996	17461-90J01		CEF500367	24,30	86,00	31,70
DT200	1998-2003	17461-90J00		CEF500367	24,30	86,00	31,70
DT225	1998-2003	17461-90J00		CEF500367	24,30	86,00	31,70



Modelo Model Modello	AÑO YEAR ANNO	R.O. OEM	Ref. RECMAR	Ref. CEF	Medidas / Measurements / Misure		
					A	B	C
DF2,5	2003+	17461-97110	REC17461-97110				
DF4	2003+	17461-98503	REC17461-98503	CEF500336	10,15	41,00	14,00
DF6	2003+	17461-98503	REC17461-98503	CEF500336	10,15	41,00	14,00
DF8	2010+	17461-93903	REC17461-93903	CEF500329	13,20	42,00	22,00
DF9,9	2004+	17461-93903	REC17461-93903	CEF500329	13,20	42,00	22,00
DF15	20004+	17461-93903	REC17461-93903	CEF500329	13,20	42,00	22,00
DF25	1999-2010	17461-96312	REC17461-96312	CEF500362G	17,10	67,50	16,18
DF30	1999-2007	17461-96312	REC17461-96312	CEF500362G	17,10	67,50	16,18
DF40	1999+	17461-96312	REC17461-96312	CEF500362G	17,10	67,50	16,18
DF50	1999+	17461-96312	REC17461-96312	CEF500362G	17,10	67,50	16,18
DF60	1998-2009	17461-87E10,11,12	REC17461-87E12	CEF500365	22,20	78,30	35,10
DF70	1998+	17461-87E10,11,12	REC17461-87E12	CEF500365	22,20	78,30	35,10
DF80	2010+	17461-87E10,11,12	REC17461-87E12	CEF500365	22,20	78,30	35,10
DF90	2010+	17461-87E10,11,12	REC17461-87E12	CEF500365	22,20	78,30	35,10
DF100	2001+	17461-90J01		CEF500367	24,30	86,00	31,70
DF115	2002+	17461-90J01		CEF500367	24,30	86,00	31,70
DF140	2002+	17461-90J01		CEF500367	24,30	86,00	31,70
DF150	2008+	17461-90J01		CEF500367	24,30	86,00	31,70
DF175	2007+	17461-90J01		CEF500367	24,30	86,00	31,70
DF200	2004+	17461-93J00		CEF500393	24,30	87,00	39,00
DF225	2004+	17461-93J00		CEF500393	24,30	87,00	39,00
DF250	2004+	17461-93J00		CEF500393	24,30	87,00	39,00
DF300	2007+	17461-93J00		CEF500393	24,30	87,00	39,00

## COLAS LOWER UNIT PIEDI

### CUERPOS BOMBA WATER PUMP HOUSING CORPO POMPA D'ACQUA

Ref. R.O.  
REC17411-93901 17411-93901

MOTORES / ENGINES / MOTORI  
DT9.9 / DT15 K1-K4 (2001-04)  
DT9.9K / DT15K-G-Y (1986-00)



Ref. R.O.  
REC17411-94421 17411-94421

MOTORES / ENGINES / MOTORI  
DF40 / DF50X-K10 (1999-10)  
DT20 / DT25 / DT30G-Y (1986-00)  
DT25 / DT30 K1-K2 (2001-02)  
DT40C-W-G-X (1986-99)  
DT40W K1-K4 (2001-04)



### KITS REPARACIÓN BOMBA AGUA WATER PUMP SERVICE KITS KIT RICAMBI POMPE ACQUA

Ref. R.O.  
REC17400-95351 17400-95550, 17400-95350, 17400-95351

MOTORES / ENGINES / MOTORI  
DT75 / DT85J-Y (1988-00)



Ref. R.O.  
REC17400-94701 17400-94700, 17400-94701

MOTORES / ENGINES / MOTORI  
DT55 / DT65J-X (1988-99)



Ref. R.O.  
REC17400-96403 17400-96350, 17400-96403

MOTORES / ENGINES / MOTORI  
DT20 / DT25 / DT30G-Y (1986-00)  
DT40C-W-G-X (1986-99)  
DT25C / DT30C-K-Y (1989-00)



Ref. R.O.  
REC17400-93J01 17400-93J00, 17400-93J01

MOTORES / ENGINES / MOTORI  
DF200 / DF225 / DF250 (2004-12)



Ref. R.O.  
REC17400-98661 17400-98661

MOTORES / ENGINES / MOTORI  
DF4 / DF5 / DF6 (2002-14)



Ref. R.O.  
REC17400-98J01 17400-98J00, 17400-98J01

MOTORES / ENGINES / MOTORI  
DF300AP (2012)  
DF300T/Z (2007-11)



Ref. R.O.  
REC17400-87D11 17400-87D10

MOTORES / ENGINES / MOTORI  
V6H-Y (1987-00)  
DT150 / DT200 / DT225W-K3 (1998-03)



Ref. R.O.  
REC17400-87E04 17400-87E03

MOTORES / ENGINES / MOTORI  
DT90 / DT100L-Y (1990-00)  
DF60 / DF70W-K9 (1998-09)



Ref. R.O.  
REC17400-92D01 17400-92D01, 17400-92D11

MOTORES / ENGINES / MOTORI  
DT8C / DT9.9C-J-V (1988-97)



Ref. R.O.  
REC17400-93951 17400-93950

MOTORES / ENGINES / MOTORI  
DF9.9 / DF15T-K3 (1996-03)  
DT9.9K / DT15K-G-Y (1986-00)  
DT15C (1989-97)



Ref. R.O.  
REC17400-94611 17400-94611

MOTORES / ENGINES / MOTORI  
DT115 / DT140G-Y (1986-00)

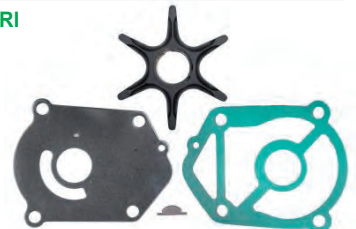

Ref.	R.O.
REC17400-90J20	17400-90J11

**MOTORES / ENGINES / MOTORI**  
DF90 / DF100 / DF115K1-K11 (2001-11)  
DF140 (2002-11)

Ref.	R.O.
REC17400-98551	17400-98551

**MOTORES / ENGINES / MOTORI**  
DT5 / DT6 / DT8G-Y (1986-00)  
DT6 / DT8Y-K2 (2000-02)

Ref.	R.O.
REC17400-98652	17400-98652, 17400-98661

**MOTORES / ENGINES / MOTORI**  
DT4 / J4 / DT5Y (1988-02)  
DT4K1 (2001)

### CHAVETA / KEY / CIAVETTA

Ref.	R.O.
REC09420-03005	09420-03005

**MOTORES / ENGINES / MOTORI**  
DT8 (1988-97)      DF8 (2008+)  
DT9.9 (1983-97)      DF9.9 (1983+)  
DT15 (1983-88)      DF15 (1983+)

Ref.	R.O.
REC17462-93990	17462-93990

**MOTORES / ENGINES / MOTORI**  
DT9.9 (1983-87)      DF9.9 (2004-10)  
DT15 (1983-97)      DF15 (2004-10)

### TAPA IMPULSOR IMPELLER PLATE PIASTRA GIRANTE

Ref.	R.O.
REC17471-93902	17471-93902

**MOTORES / ENGINES / MOTORI**  
DF9.9(R)T-K3 (1996-11)  
DF15(R)-K3 (1996-12)  
DT15C (1989-97)  
DT9.9 / DT15K1-K4 (2001-04)  
DT9.9K / DT15K-G-K4 (2001-04)  
DT9.9K / DT15K-G-Y (1986-00)

Ref.	R.O.
REC17471-94401	17471-94401

**MOTORES / ENGINES / MOTORI**  
DF25 / DF30Y-K6 (2000-06)  
DF40 / DF50X-K10 (1999-10)  
DF20 / DF25 / DF30G-Y (1986-00)  
DF25C / DT30C-K-Y (1989-00)  
DT40C-W-G-X (1986-99)  
DT25 / DT30 K1-K2 (2001-02)  
DT40W - K1-K4 (2001-04)

### TAPA BOMBA WATER PUMP PLATE PIASTRA POMPA ACQUA

Ref.	R.O.
REC56130-94413-0EP	56130-94413-0EP

**MOTORES / ENGINES / MOTORI**  
DF40 / DF50X-K10 (1999-10)  
DF40W-K1-K4 (2001-04)

### JUNTA BASE BOMBA CASE PANEL GASKET GUARNIZIONI BASE POMPA

Ref.	R.O.
REC17472-98J00	17472-98J00

**MOTORES / ENGINES / MOTORI**  
DF200 / DF225 / DF250 (2004-15)  
DF300AP-T/Z (2007-12)

### JUNTA COLA DRIVE GASKET GUARNIZIONI PIEDI

Ref.	R.O.
REC17452-93910	17452-93910

**MOTORES / ENGINES / MOTORI**  
DF9.9 / DF15T-K3 (1996-03)  
DT15C (1989-97)  
DT9.9K / DT15K-G-Y (1986-00)  
DT9.9 / DT15 K1-K4 (2001-04)

Ref.	R.O.
REC17472-91J00	17472-91J00

**MOTORES / ENGINES / MOTORI**  
DF4 / DF5 / DF6 (2002-14)

Ref.	R.O.
REC17472-93J00	17472-93J00

**MOTORES / ENGINES / MOTORI**  
DF200 / DF225 / DF250 (2004+)  
DF200A (2015)  
DF150 / DF175T-Z (G) (2006-14)

Ref.	R.O.
REC17472-96303	17472-96301

**MOTORES / ENGINES / MOTORI**  
DF20R / DF25R-V2 (2006-11)  
DF40 / DF50X-K10 (1999-10)  
DF40A / DF50A / DF60A (2010+)



Ref.	R.O.
REC17472-94510	17472-94510

**MOTORES / ENGINES / MOTORI**  
DT115 / DT140G-Y (1986-00)

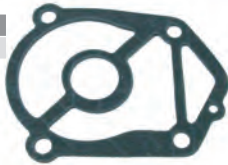

Ref.	R.O.
REC17472-95200	17472-95200

**MOTORES / ENGINES / MOTORI**  
DT75 / DT85-J-Y (1988-00)



Ref.	R.O.
REC17472-95310	17472-95310

**MOTORES / ENGINES / MOTORI**  
DT55 / DT65J-X (1988-99)



Ref.	R.O.
REC25142-94520	25142-94520

**MOTORES / ENGINES / MOTORI**  
DT115 / DT140G-Y (1986-00)



Ref.	R.O.
REC17472-98503	17472-98503

**MOTORES / ENGINES / MOTORI**  
DT5 / DF6 / DT8G-Y (1986-00)  
DT6 / DT8Y-K2 (2000-02)



Ref.	R.O.
REC17472-93911	17472-93911

**MOTORES / ENGINES / MOTORI**  
DF9.9 / DF15T-K3 (1996-03)  
DT15C (1989-97)  
DT9.9K / DT15K-G-Y (1986-00)  
DT9.9 / DT15K1-K4 (2001-04)



Ref.	R.O.
REC17472-92D10	17472-92D10

**MOTORES / ENGINES / MOTORI**  
DT8C / DT9.9C-J-V (1988-97)



Ref.	R.O.
REC17472-98611	17472-98611

**MOTORES / ENGINES / MOTORI**  
DT4 / J4 / DT5Y (1988-00)  
DT4K1 (2001)  
DT5Y (1998-02)



Ref.	R.O.
REC55122-94400	55122-88L00

**MOTORES / ENGINES / MOTORI**  
DF40 / DF50X-K10 (1999-10)  
DF40A / DF50A / DF60A (2010+)

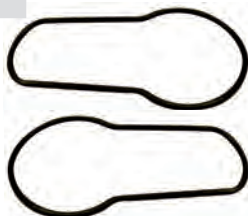

## KIT JUNTAS Y RETENES COLA LOWER UNIT SEAL KITS KIT GUARNIZIONI E TENUTE PIEDE

Ref.	R.O.
REC25700-95D01	25700-95D01, 25700-95D00

**MOTORES / ENGINES / MOTORI**  
DF25 / DF30Y-K6 (2000-06)  
DT25C / DT30C-K-Y (1989-00)



Ref.	R.O.
REC25700-88400	25700-94400, 27700-88400

**MOTORES / ENGINES / MOTORI**  
DF40 / DF50X-K10 (1999-10)  
DF40A / DF50A / DF60A (2010-13)



Ref.	R.O.
REC25700-94700	25700-94700

**MOTORES / ENGINES / MOTORI**  
DT55 / DT65J-X (1988-99)



Ref.	R.O.
REC25700-95501	25700-95500

**MOTORES / ENGINES / MOTORI**  
DT75 / DT85J-Y (1988-00)



Ref.	R.O.
REC25700-94500	25700-94500

**MOTORES / ENGINES / MOTORI**  
DT115 / DT140G-Y (1986-00)

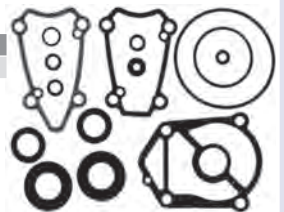

Ref.	R.O.
REC25700-90J01	25700-90J01

**MOTORES / ENGINES / MOTORI**  
DF90 / DF100 / DF115 K1-K11 (2001-11)  
DF115WT / DF140WT-K3 (2003)

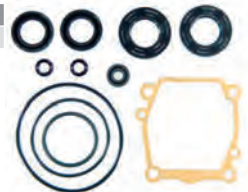

Ref.	R.O.
REC25700-92J00	25700-92J00

**MOTORES / ENGINES / MOTORI**  
DF100A / DF115A / DF140A (2013+)  
DF140 (2002-12)

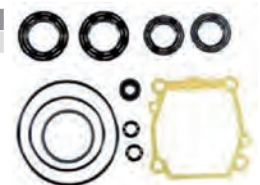

Ref.	R.O.
REC25700-87D00	25700-87D00

**MOTORES / ENGINES / MOTORI**  
DT150 / DT200 / DT225W-K3 (1998-03)  
V6H-Y (1987-00)

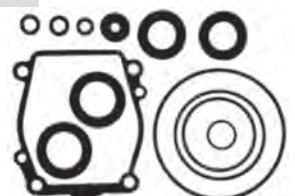

Ref.	R.O.
REC25700-93J00	25700-93J00

**MOTORES / ENGINES / MOTORI**  
 DF150 / DF175T/Z (G) (2006-14)  
 DF200 / DF225 / DF250 (2004+)  
 DF200A (2015)



Ref.	R.O.
REC25700-99E00	25700-99E00

**MOTORES / ENGINES / MOTORI**  
 DF40A / DF50A / DF60A (2014+)  
 DF60 / DF70W-K9 (1998-09)



Ref.	R.O.
REC25700-95J00	25700-95J00

**MOTORES / ENGINES / MOTORI**  
 DF20R / DF25 / DF25R-V2 (2006-11)



Ref.	R.O.
REC25700-98J00	25700-98J00

**MOTORES / ENGINES / MOTORI**  
 DF300T/Z (2007-11)

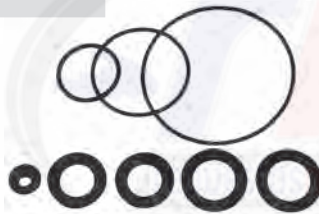

## GUÍA KITS RETENES SEAL KIT APPLICATION GUIDA KIT TENUTE

Modelo Model Modello	AÑO YEAR ANNO	Ref. R
DF20R/DF25/DF25R V2	2006-2011	REC25700-95J00
DT25C/DT30C-K-Y	1989-2000	REC25700-95D01
DF25/DF30Y-K6	2000-2006	REC25700-95D01
DF40/DF50X-K10	1999-2010	REC25700-88400
DF40A/DF50A/DF60A	2013+	REC25700-99E00
DF40A/DF50A/DF60A	2010-2012	REC25700-88400
DT55/DT65J-X	1988-1999	REC25700-94700
DF60/DF70W-K9	1998-2009	REC25700-99E00
DT75/DT85J-Y	1988-2000	REC25700-95501
DF90/DF100/DF115K1-K11	2001-2011	REC25700-90J01
DF100A/DF115A/DF140A	2013+	REC25700-92J00
DT115/DT140G-Y	1986-2000	REC25700-94500
DF115WT/DF140WT-K3	2003-2003	REC27500-90J01
DF140	2002-2012	REC27500-92J00
DF150/DF175T-Z(G)	2006-2014	REC25700-93J00
DT150/DT200/DT225W-K3	1998-2003	REC25700-87D00
DF200A	2015+	REC25700-93J00
DF200/DF225/DF250	2004+	REC25700-93J00
V6H-Y	1987-2000	REC25700-87D00
DF300T/Z	2007-2011	REC25700-98J00

## ARANDELA PIÑÓN ATAQUE WASHER GEAR RONDELLA PIGNONE INNESTO

Ref.	R.O.
REC09160-26015	09160-26015

**MOTORES / ENGINES / MOTORI**  
 DF40 / DF50X-K10 (1999-10)  
 DF40C-W-G-X (1986-99)  
 DF40W-K1-K4 (2001-04)

26.2 x 42 x 4.0 mm



Ref.	R.O.
REC09160-21009	09160-21009

**MOTORES / ENGINES / MOTORI**  
 DF8A / DF8AR / DF9.9A / DF9.9AR (2010+)  
 DF9.9 / DF15T-K3 (1996-03)  
 DF15 (2012)  
 DF9.9 / DF15(R) (2004-11)  
 DF9.9B / DF15A / DF20A (2013)  
 DT9.9K / DT15G-Y (1986-00)  
 DT15C (1989-97)  
 DT9.9 / DT15K1-K4 (2001-04)

21 x 35 x 2.75 mm



Ref.	R.O.
REC09160-20027	09160-20027

**MOTORES / ENGINES / MOTORI**  
 DF9.9 (2004-10)  
 DT/DF15 (1983-2015)  
 DF20 (2011-2015)



## GRUESO PIÑÓN ATAQUE SHIM GEAR SPESSORE PIGNONE INNESTO

Ref.	R.O.	T:1.0
REC09160-20041	09160-20041	T:1.0

**MOTORES / ENGINES / MOTORI**  
 DT9.9 (1983-87)  
 DT15 (1983-97)



Ref.	R.O.	T:1.1	T:1.2	T:0.7
REC09160-20042	09160-20042	T:1.1		
REC09160-20043	09160-20043		T:1.2	
REC09160-20044	09160-20044			T:0.7

**MOTORES / ENGINES / MOTORI**  
 DF8A / DF8AR / DF9.9A / DF9.9AR (2010+)  
 DF9.9 / DF15T-K3 (1996-03)  
 DF15 (2012)  
 DF9.9 / DF15(R) (2004-11)  
 DF9.9B / DF15A / DF20A (2013)  
 DT9.9K / DT15G-Y (1986-00)  
 DT15C (1989-97)  
 DT9.9 / DT15K1-K4 (2001-04)



## TUERCA VARILLA CAMBIO TURNBUCKE, CATCH ROD DADO ASTA CAMBIO

Ref.	R.O.
REC23311-95DL0	

**MOTORES / ENGINES / MOTORI**  
 DF25 / DF30Y-K6 (2000-06)  
 DF40 / DF50X-K10 (1999-10)  
 DF9.9 / DF15T-K3 (1996-03)  
 DF9.9 / DF15 (R) (2004-11)  
 DT9.9 / DT40





## EXTREMO SELECTOR ARM, CLUTCH ROD SELETTORE

Ref. R.O.  
REC23211-94401

MOTORES / ENGINES / MOTORI  
DT25C / DT30C-K-Y (1989-00)  
DT40C-W-G-X (1986-99)  
DT40W-K1K4 (2001-04)



## KIT CIERRE HÉLICES PROP NUT KITS KIT CHIUSURA ELICA

Ref. R.O.  
REC57630-96300

MOTORES / ENGINES / MOTORI  
DF20R / DF25 / DF25R V2 (2006-11)  
DF25 / DF30Y-K6 (2000-06)  
DT20 / DT25 / DT30G-Y (1986-00)  
DT25 / DT30K1-K2 (2001-02)  
DT25C / DT30C-K-Y (1989-00)



Ref. R.O.  
REC57630-94500

MOTORES / ENGINES / MOTORI  
DF40A / DF50A / DF60A (2014)  
DF60 / DF70W-K9 (1998-09)  
DT75 / DT85J-Y (1988-00)  
DT90 / DT100L-Y (1990-00)  
DT115 / DT140G-Y (1986-00)



Ref. R.O.  
REC57630-94300 57630-94300

MOTORES / ENGINES / MOTORI  
DF40 / DF50X-K10 (1999-10)  
DF40A / DF50A / DF60A (2010-15)  
DT40C-W-G-X (1986-99)  
DT40W-K1-K4 (2001-04)  
DT55 / DT65J-X (1988-99)

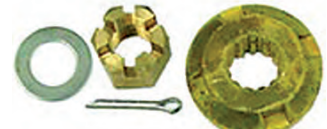

Ref. R.O.  
REC57630-92E00 57630-92E00

MOTORES / ENGINES / MOTORI  
DF150 / DF175Z-T(G) (2006-14)  
DF200 / DF225 / DF250 (2004+)  
DF200A (20015+)  
DF300A-T-Z (2007-12)  
DF150 / DT200 / DT225W-K3 (1998-03)  
V6 H-Y (1987-00)



## CASQUILLO BASCULANTE BUSH, SWIVEL TAPO GIREVOLE

Ref. R.O.  
REC43211-87JL0 43211-87JL0

MOTORES / ENGINES / MOTORI  
DF8 (2010+)  
DF9.9 (2004+)  
DF15 (2004+)  
DF20 (2011+)



Ref. R.O.  
REC43211-94401 43211-94401

MOTORES / ENGINES / MOTORI  
DF15 (1989-97) DF9.9 (2006-10)  
DT35 (1986-89) DF15 (2004-10)  
DT40 (1986-98) DF25 (2000-07)  
DF30 (2000-07)  
DF40 (1999-10)  
DF50 (1999-10)



## GUÍA PIEZAS COLA STERN DRIVE COMPONENTS APPLICATIONS GUIDA RICAMBI PIEDE

MODELO MODEL MODELLO	DESDE FROM DELL' ANNO	HASTA TO ALL' ANNO	PIÑÓN ATAQUE GEAR PIGNONE INNESTO	PIÑÓN AVANTE GEAR FORWARD PIGNONE MARCIA AVANTI	PIÑÓN M. ATRÁS GEAR REVERSE PIGNONE MAR. INDIETRO	PIÑÓN M. ATRÁS GEAR REVERSE PIGNONE MAR. INDIETRO	EJE HÉLICE PROPELLER SHAFT ASSE ELICA	"L" EJE VERTICAL DRIVESHAFT ASSEMBLY ASSE VERT.	"S" EJE VERTICAL DRIVESHAFT ASSEMBLY ASSE VERT.	DIÁBOLO CARRIER INGRANAGGI
DT2	1986	2000	REC57311-98400							
DT2.2 K1-K5	2001	2005	REC57311-98400							
DT 9.9K DT15 K-G-Y	1986	2000	REC57311-93901	REC57510-93902	REC57521-93902		REC57610-93901	REC57100-93902	REC57100-93912	REC56120-93900-0ED
DT9.9 DT15 K1-K4	2001	2004	REC57311-93910	REC57510-93910	REC57521-93910		REC57610-93901	REC57100-93902	REC57100-93912	REC56120-93900-0ED
DF9.9 DF15T-K3	1996	2003	REC57311-93910	REC57510-93910	REC57521-93910		REC57610-93901	REC57100-93902	REC57100-93912	REC56120-93901-0EP
DF9.9 DF15 R	2004	2011	REC57311-93910	REC57510-93910	REC57521-93910		REC57610-93901	REC57100-93902	REC57100-93912	REC56120-93901-0EP
DT 15 C	1989	1997	REC57311-93901	REC57510-93902	REC57521-93902		REC57610-93901			REC56120-93900-0ED
DF 15	2012	2012					REC57610-93901	REC57100-93902	REC57100-93912	
DT20 DT25 DT30 G-Y	1986	2000	REC57311-96311	REC57510-89J00	REC57521-96312					
DT25 C DT30 C-K-Y	1989	2000	REC57311-96311	REC57510-89J00	REC57521-96312					
DT25 DT30 K1-K2	2001	2002	REC57311-96320	REC57510-89J00	REC57521-89J00					
DF25 DF30 Y-K6	2000	2006	REC57311-96320	REC57510-89J00	REC57521-89J00					
DT40C-W-G-X	1986	1999	REC57311-94402	REC57510-94402	REC57521-94400			REC57110-94441	REC57110-94411	
DT40W-K1-K4	2001	2004	REC57311-94402	REC57510-94402	REC57521-94400			REC57110-94441	REC57110-94411	
DF40 DF50X-K10	1999	2010				REC57621-94403				

# GUÍA MANTENIMIENTO MAINTENANCE GUIDE GUIDA DI MANUTENZIONE

Modelo Model Modello	DESCRIPCIÓN	DESCRIPTION	DESCRIZIONE	Unidades Units Unità	Ref.
DF4 DF5 DF6	BUJÍA	SPARK PLUG	CANDELE	1	NGKBPR6ES
	ÁNODO	ANODE DRIVE	ANODO	1	CM55321-87J00
	IMPULSOR	IMPELLER	GIRANTE	1	REC17461-98503
	FILTRO COMBUSTIBLE	FUEL FILTER	FILTRO BENZINA	1	REC15410-98500
DF8A DF9.9A	BUJÍA	SPARK PLUG	CANDELE	2	NGKCR6E
	ÁNODO BLOQUE	ANODE ENGINE	ANODO MOTORE	1	CM55321-87J00
	IMPULSOR	IMPELLER	GIRANTE	1	REC17461-93903
	FILTRO COMBUSTIBLE	FUEL FILTER	FILTRO BENZINA	1	REC15410-98500
	FILTRO ACEITE	OIL FILTER	FILTRO OLIO	1	REC16510-05240
DF15A DF20A	BUJÍA	SPARK PLUG	CANDELE	2	NGKCP6EA-9
	BUJÍA	SPARK PLUG	CANDELE	1	REC17461-93903
	ÁNODO BLOQUE	ANODE ENGINE	ANODO MOTORE	2	CM55321-87J00
	FILTRO ACEITE	OIL FILTER	FILTRO OLIO	1	REC16510-05240
DF25	BUJÍA	SPARK PLUG	CANDELE	2	NGKBKR6E
	ÁNODO BLOQUE	ANODE ENGINE	ANODO MOTORE	4	CM55321-87J00
	ÁNODO COLA	ANODE DRIVE	ANODO PIEDE	1	CM55125-96310
	IMPULSOR	IMPELLER	GIRANTE	1	REC17461-96312
	FILTRO COMBUSTIBLE	FUEL FILTER	FILTRO BENZINA	1	REC15410-87J30
	FILTRO ACEITE	OIL FILTER	FILTRO OLIO	1	REC16510-87J00
DF40 DF50	BUJÍA	SPARK PLUG	CANDELE	3	NGKDCPR6E
	ÁNODO BLOQUE	ANODE ENGINE	ANODO MOTORE	5	CM55321-87J00
	ÁNODO COLA	ANODE DRIVE	ANODO PIEDE	1	CM55125-95500
	ZINC TRANSOM	ANODE TRANSOM	ANODO ZINCO TRANSOM	2	TEN01204
	IMPULSOR	IMPELLER	GIRANTE	1	REC17461-96312
	FILTRO COMBUSTIBLE	FUEL FILTER	FILTRO BENZINA	1	REC15410-87J30
	FILTRO COMUSTIBLE ALTA	FUEL FILTER HIGH	FILTRO BENZINA ALTA	1	REC15410-87J00
	FILTRO ACEITE	OIL FILTER	FILTRO OLIO	1	REC16510-87J00
DF40A DF50A	BUJÍA	SPARK PLUG	CANDELE	3	NGKDCPR6E
	ÁNODO BLOQUE	ANODE ENGINE	ANODO MOTORE	5	CM55321-87J00
	ÁNODO COLA	ANODE DRIVE	ANODO PIEDE	1	CM55300-95500
	ZINC TIMÓN	TRIM TAB ANODE	ANOD ZINCO TRIM TAB	1	TEN01207
	ZINC TRANSOM	ANODE TRANSOM	ANODO ZINCO TRANSOM	1	TEN01214
	IMPULSOR	IMPELLER	GIRANTE	1	REC17461-96312
	FILTRO ACEITE	OIL FILTER	FILTRO OLIO	1	REC16510-87J00
DF60 DF70	BUJÍA	SPARK PLUG	CANDELE	4	NGKBPR6ES
	ÁNODO BLOQUE	ANODE ENGINE	ANODO MOTORE	2	CM55321-87J00
	ÁNODO COLA	ANODE DRIVE	ANODO PIEDE	1	CM55321-90J01
	ZINC TRANSOM	ANODE TRANSOM	ANODO ZINCO TRANSOM	1	TEN01214
	ZINC CAÑA	ANODE HOUSING	ANODO ZINCO CORPO	1	TEN01204
	IMPULSOR	IMPELLER	GIRANTE	1	REC17461-87E12
	FILTRO COMBUSTIBLE	FUEL FILTER	FILTRO BENZINA	1	REC15410-87J30
	FILTRO ACEITE	OIL FILTER	FILTRO OLIO	1	REC16510-87J00
DF60A	BUJÍA	SPARK PLUG	CANDELE	3	NGKDCPR6E
	ÁNODO COLA	ANODE DRIVE	ANODO PIEDE	1	CM55125-95500
	ZINC TRANSOM	ANODE TRANSOM	ANODO ZINCO TRANSOM	1	TEN01214
	ZINC CAÑA	ANODE HOUSING	ANODO ZINCO CORPO	1	CM55300-95500
	IMPULSOR	IMPELLER	GIRANTE	1	REC17461-96312
	FILTRO COMBUSTIBLE	FUEL FILTER	FILTRO BENZINA	1	REC15410-87L00
	FILTRO ACEITE	OIL FILTER	FILTRO OLIO	1	REC16510-87L00

Modelo Model Modello	DESCRIPCIÓN	DESCRIPTION	DESCRIZIONE	Unidades Units Unità	Ref.
DF70A DF80A DF90A	BUJÍA	SPARK PLUG	CANDELE	4	NGKDCPR6E
	ÁNODO COLA	ANODE DRIVE	ANODO PIEDE	1	CM55321-90J01
	ZINC TRANSOM	ANODE TRANSOM	ANODO ZINCO TRANSOM	1	TEN01214
	ÁNODO BLOQUE	ANODE ENGINE	ANODO MOTORE	4	CM55321-87J00
	IMPULSOR	IMPELLER	GIRANTE	1	REC17461-87E12
	FILTRO ACEITE	OIL FILTER	FILTRO OLIO	1	REC16510-90J00
DF90 DF100 DF115	BUJÍA	SPARK PLUG	CANDELE	4	NGKBKR6E
	ÁNODO COLA	ANODE DRIVE	ANODO PIEDE	1	CM55321-90J01
	ZINC TRANSOM	ANODE TRANSOM	ANODO ZINCO TRANSOM	1	TEN01214
	ÁNODO BLOQUE	ANODE ENGINE	ANODO MOTORE	4	CM55321-87J00
	IMPULSOR	IMPELLER	GIRANTE	1	REC17461-90J01
	FILTRO COMBUSTIBLE	FUEL FILTER	FILTRO BENZINA	1	REC15410-97J30
	FILTRO ACEITE	OIL FILTER	FILTRO OLIO	1	REC16510-90J00
DF140	BUJÍA	SPARK PLUG	CANDELE	4	NGKBKR6E
	ÁNODO COLA	ANODE DRIVE	ANODO PIEDE	1	CM55321-90J01
	ZINC TRANSOM	ANODE TRANSOM	ANODO ZINCO TRANSOM	1	TEN01214
	ÁNODO BLOQUE	ANODE ENGINE	ANODO MOTORE	4	CM55321-87J00
	IMPULSOR	IMPELLER	GIRANTE	1	REC17461-90J01
	FILTRO COMBUSTIBLE	FUEL FILTER	FILTRO BENZINA	1	REC15410-87J30
	FILTRO ACEITE	OIL FILTER	FILTRO OLIO	1	REC16510-92J00
DF100A DF115A DF140A	BUJÍA	SPARK PLUG	CANDELE	4	NGKBKR6E
	ÁNODO COLA	ANODE DRIVE	ANODO PIEDE	1	CM55321-90J01
	ZINC TRANSOM	ANODE TRANSOM	ANODO ZINCO TRANSOM	1	TEN01214
	ÁNODO BLOQUE	ANODE ENGINE	ANODO MOTORE	7	CM55321-87J00
	IMPULSOR	IMPELLER	GIRANTE	1	REC17461-90J01
	FILTRO ACEITE	OIL FILTER	FILTRO OLIO	1	REC16510-93J00
DF150 DF175	BUJÍA	SPARK PLUG	CANDELE	4	NGKBKR6E
	ÁNODO COLA	ANODE DRIVE	ANODO PIEDE	2	TEN01204
	ZINC TRANSOM	ANODE TRANSOM	ANODO ZINCO TRANSOM	1	TEN01214
	ÁNODO BLOQUE	ANODE ENGINE	ANODO MOTORE	5	CM55321-87J00
	IMPULSOR	IMPELLER	GIRANTE	1	REC17461-90J01
	FILTRO COMBUSTIBLE	FUEL FILTER	FILTRO BENZINA	1	REC15410-96J00
	FILTRO ACEITE	OIL FILTER	FILTRO OLIO	1	REC16510-96J00
DF200 DF225 DF250	BUJÍA	SPARK PLUG	CANDELE	6	NGKBKR6E
	ÁNODO COLA	ANODE DRIVE	ANODO PIEDE	3	TEN01204
	ZINC TRANSOM	ANODE TRANSOM	ANODO ZINCO TRANSOM	1	TEN01214
	ÁNODO BLOQUE	ANODE ENGINE	ANODO MOTORE	7	CM55321-87J00
	IMPULSOR	IMPELLER	GIRANTE	1	REC17461-93J00
	FILTRO COMBUSTIBLE	FUEL FILTER	FILTRO BENZINA	1	REC65L-24563-00
	FILTRO ACEITE	OIL FILTER	FILTRO OLIO	1	REC16510-96J00
DF300	BUJÍA	SPARK PLUG	CANDELE	6	NGKBKR6E
	ÁNODO COLA	ANODE DRIVE	ANODO PIEDE	2	TEN01204
	ZINC TRANSOM	ANODE TRANSOM	ANODO ZINCO TRANSOM	1	TEN01214
	ÁNODO BLOQUE	ANODE ENGINE	ANODO MOTORE	6	CM55321-87J00
	IMPULSOR	IMPELLER	GIRANTE	1	REC17461-93J00
	FILTRO COMBUSTIBLE	FUEL FILTER	FILTRO BENZINA	1	REC65L-24563-00
	FILTRO ACEITE	OIL FILTER	FILTRO OLIO	1	REC16510-96J00



# GUÍA DE HÉLICES ALUMINO E INOXIDABLES DE 3 Y 4 PALAS 3 & 4 BLADE ALUMINUM & STAINLESS STEEL PROPELLERS APPLICATION GUIDA ELICHE ALLUMINIO E INOX DA 3 E 4 PALE

HP	R.O. OEM	B	D	P	R	TIPO TYPE	ALUMINIO ALUMINIUM ALLUMINIUM		INOX STAINLESS STEEL		
							AMITA 3	AMITA 4	NEW SATURN	LEXOR	HR TITAN 3
DF4, DF5, DF6 (2004+)		3	8	7	R	ALUM.	SOL4011-079-07S				
10 Estrías / tooth spline / denti											
DT9.9 / DT15 (1983-97)		3	9.25	7	R	ALUM.	SOL4111-093-07A				
DF8 (2010+)		3	9.25	8	R	ALUM.	SOL4111-093-08A				
DF9.9 / DF15 (1996+)		3	9.25	9	R	ALUM.	SOL4111-093-09A				
DF20 (2013+)		3	9.25	10	R	ALUM.	SOL4111-093-10A				
10 Estrías / tooth spline / denti		3	9.25	11	R	ALUM.	SOL4111-093-11A				
		3	9.25	12	R	ALUM.	SOL4111-093-12A				
DT20, 25, 25C	58100-96410-019	3	10 1/4	10	R	ALUM.	SOL4211-110-09				
DT30, 30C	58100-96420-019	3	10 1/4	11	R	ALUM.	SOL4211-105-11				
DF25, 30	58100-96430-019	3	10 1/4	12	R	ALUM.	SOL4211-103-12				
	58100-96440-019	3	10 1/4	13	R	ALUM.	SOL4211-101-13				
	58100-95D00-019	3	10 1/4	14	R	ALUM.	SOL4211-100-14				
Thru-Hub	58100-96460-019	3	10 1/4	15	R	ALUM.	SOL4211-100-15				
10 Estrías / tooth spline / denti											
DT35, DT40, DT50,	58100-94302-019	3	11 1/2	9	R	ALUM.	SOL4311-121-09				
DT55, DT60, DT65	58100-95212-019	3	11 1/2	10	R	ALUM.	SOL4311-120-10				
DF40, DF50, DF60	58100-95222-019	3	11 1/2	11	R	ALUM.	SOL4311-118-11				
(2010+)	58100-95393-019	3	11 5/8	12	R	ALUM.	SOL4311-116-12				
	58100-94313-019	3	11 1/2	13	R	ALUM.	SOL4311-116-13				
	58100-95353-019	3	11 3/8	14	R	ALUM.	SOL4311-116-14				
13 Estrías / tooth spline / denti	58100-95363-019	3	11	15	R	ALUM.	SOL4311-110-15				
DT75, DT85, DT90		3	14	11	R	ALUM.	SOL4411-140-11				
DT100, DT115, DT140		3	13 3/4	13	R	ALUM.	SOL4411-138-13	SOL4413-133-13			
DF60, DF70 (1998-08)	58100-94500-019	3	13 1/2	15	R	V1500	SOL4411-135-15	SOL4413-130-15	SOL4431-135-15		
	58100-94512-019	3	13 1/4	17	R	V1700	SOL4411-133-17	SOL4413-128-17	SOL4431-133-17		
	58100-94522-019	3	13	19	R	V1900	SOL4411-130-19	SOL4413-125-19	SOL4431-130-19		
Thru-hub	58100-94532-019	3	13	21	R	V2100	SOL4411-130-21	SOL4413-125-21	SOL4431-130-21		
13 Estrías / tooth spline / denti	58100-95511-019	3	13 1/4	17	R	U1700			SOL2431-135-15		
	58100-95521-019	3	13	19	R	U1900			SOL2431-133-17		
	58100-95530-019	3	13	21	R	U2100			SOL2431-130-19		
DF60, DF70, DT75-140	58100-94554-019	3	13 1/2	15	R	S.S.			SOL4431-135-15		
Arandela 13 dientes	58100-94581-019	3	13 1/4	17	R	S.S.			SOL4431-133-17		
13 tooth spline Trhust Washer	58100-94561-019	3	13	19	R	S.S.			SOL4431-130-19		
Rondella 13 denti	58100-94571-019	3	13	21	R	S.S.			SOL4431-130-21		
	99105-00100-16P	3	13 1/4	16	R	S.S.			SOL4431-135-15		
	99105-00100-18P	3	13 1/4	18	R	S.S.			SOL4431-133-17		
	99105-00100-20P	3	13 1/4	20	R	S.S.			SOL4431-130-19		
DF70A, DF80A, DF90A	99105-00100-22P	3	13 1/4	22	R	S.S.			SOL4431-130-21		
DF90, DF115, DF140		3	13 1/4	22	R	S.S.			SOL4431-130-21		
Arandela 15 dientes											
15 tooth spline Trhust Washer											
Rondella 15 denti											
DF70A, DF80A, DF90A	58100-90J40-019	3	15	15	R	ALUM.	SOL3411-139-17	SOL3413-138-15			
DF90, DF115, DF140	58100-90J00-019	3	14 3/4	17	R	ALUM.	SOL3411-139-19	SOL3413-138-17			SOL3451-139-17
	58100-90J10-019	3	14 1/2	19	R	ALUM.	SOL3411-139-21	SOL3413-138-19			SOL3451-139-19
	58100-90J20-019	3	14 1/4	21	R	ALUM.		SOL3413-138-21			SOL3451-139-21
	58100-90J22-019	3	14	23	R	ALUM.					SOL3451-139-23
4 Tiempos 13 Estrías	99105-00700-18P	3		18	R	S.S.					SOL3451-139-17
4 Stroke 13 tooth spline	99105-0070L-18P	3		18	L	S.S.					SOL3452-139-17
4 Tempi 13 denti	99105-00700-20P	3		20	R	S.S.					SOL3451-139-19
	99105-0070L-20P	3		2	L	S.S.					SOL3452-139-19
	99105-00700-22P	3		22	R	S.S.					SOL3451-139-21
Thru-hub	99105-0070L-22P	3		22	L	S.S.					SOL3452-139-21
	99105-00700-24P	3		24	R	S.S.					SOL3451-139-23
DT150, DT175, DT200	58200-87D61-019	3	14 1/2	16	R	S.S.		SOL4513-148-15			SOL4551-148-16
DT225	58200-87D62-019	3	14 1/2	16	L	S.S.					SOL4552-148-16
	58200-87D01-019	3	14 1/2	18	R	S.S.		SOL4513-145-17			SOL4551-148-18
	58200-87D02-019	3	14 1/2	18	L	S.S.					SOL4552-148-18
	58200-87D11-019	3	14 1/2	20	R	S.S.		SOL4513-143-19			SOL4551-148-20
	58200-87D12-019	3	14 1/2	20	L	S.S.					SOL4552-148-20
	58200-87D21-019	3	14 1/2	22	R	S.S.		SOL4513-140-21			SOL4551-143-22
	58200-87D22-019	3	14 1/2	22	L	S.S.					SOL4552-143-22
15 Estrías / tooth spline / denti	99105-00200-16P	3	15-14 1/4	15-16	R	S.S.	SOL4511-150-15				SOL4551-148-16
	99105-0020L-16P	3	15-14 1/4	15-16	L	S.S.	SOL4512-150-15				SOL4552-148-16
	99105-00200-18P	3	14.8-14 1/4	18	R	S.S.	SOL4511-148-17				SOL4551-148-18
	99105-0020L-18P	3	14.8-14 1/4	18	L	S.S.	SOL4512-148-17				SOL4552-148-18
	99105-00200-20P	3	14.5-14 1/4	20	R	S.S.	SOL4511-145-19				SOL4551-148-20
	99105-0020L-20P	3	14.5-14 1/4	20	L	S.S.	SOL4512-145-19				SOL4552-148-20
	99105-00200-22P	3	14.3-14 1/4	22	R	S.S.	SOL4511-143-21				SOL4551-143-22
	99105-0020L-22P	3	14.3-14 1/4	22	L	S.S.	SOL4512-143-21				SOL4552-143-22
	99105-00200-24P	3	14.2-14 1/4	23-24	R	S.S.	SOL4511-142-23				SOL4551-140-24
Thru-hub	99105-0020L-24P	3	14.2-14 1/4	23-24	L	S.S.	SOL4512-142-23				SOL4552-140-24

HP	R.O. OEM	B	D	P	R	TIPO TYPE	ALUMINIO ALUMINIUM		INOX STAINLESS STEEL		
							AMITA 3	AMITA 4	NEW SATURN	LEXOR	HR TITAN 3
DF150, DF175, DF200, DF225, DF250, DF300  15 Estrias / tooth spline / denti		3	15.8	15	R	ALUM.	SOL4511-150-15				
		3	15.8	15	L	ALUM.	SOL4512-158-15				
		3	15.5	17	R	ALUM.	SOL4511-155-17				
		3	15.5	17	L	ALUM.	SOL4512-155-17				
		3	15 3/8	18	R	ALUM.				SOL4571-154-18	
		3	15 3/8	18	L	ALUM.				SOL4572-154-18	
		3	15.3	19	R	ALUM.	SOL4511-153-19				
		3	15.3	19	L	ALUM.	SOL4512-153-19				
		3	15 1/8	20	R	ALUM.				SOL4571-151-20	
		3	15 1/8	20	L	ALUM.				SOL4572-151-20	
		3	15.3	21	R	ALUM.	SOL4511-153-21				
		3	15.3	21	L	ALUM.	SOL4512-153-21				
		3	14 7/8	22	R	ALUM.				SOL4571-149-22	
		3	14 7/8	22	L	ALUM.				SOL4572-149-22	
		3	14 3/4	23	R	ALUM.				SOL4571-148-23	
	3	14 3/4	23	L	ALUM.				SOL4572-148-23		

B= PALAS / Blades / Pale  
D= DIÁMETRO / Diametre / Diametro

R=ROTACIÓN / Rotation / Rotazione  
(R) Derecha / Right / DX,

(L) Izquierda / Left / SX

## HÉLICES ALUMINO E INOXIDABLES DE 3 Y 4 PALAS 3 & 4 BLADE ALUMINUM & STAINLESS STEEL PROPELLERS ELICHE ALLUMINIO E INOX DA 3 E 4 PALE

**SOLAS**

### AMITA 3

- Helices de aluminio de 3 palas con núcleo de goma de gran resistencia.
- 3 blade aluminum propeller with heavy duty rubber hub.
- Eliche di alluminio a 3 pale con mozzi in gomma ad alta resistenza.



**SOLAS**

### LEXOR PROPELLER

- Helices de acero inoxidable de 3 palas.
- Gran diámetro del área de las palas para barcos pesados.
- Gran rendimiento en alta velocidad sin sacrificar las velocidades medias.
- Excelente ahorro de combustible.
- Three blade stainless steel propeller.
- Large diameter and blade area for big boat loads.
- Great high speed performance without sacrificing mid-range speeds.
- Excellent fuel economy.
- Eliche di acciaio inox a 3 pale.
- Grande diametro delle pale per imbarcazioni pesanti.
- Grandi prestazioni ad alta velocità senza sacrificare velocità medie.
- Eccellente risparmio di carburante in navi al largo..



**SOLAS**

### AMITA 4

- Helices de aluminio de 4 palas con núcleo de goma de gran resistencia.
- Van muy suaves a poca velocidad y hace el barco muy manejable con la mar picada.
- 4 Blade aluminum propeller with heavy duty rubber hub.
- Smoother low speed makes the offshore boating activity much easier.
- Eliche di alluminio a 4 pale con mozzo in gomma ad alta resistenza.
- Molto morbida a bassa velocità e rende la barca molto maneggevole con mare cattivo.



**SOLAS**

### NEW SATURN PROP

- Helices de acero inoxidable de 3 palas.
- Ofrece buena aceleración y rendimiento.
- Tamaño más pequeño que ofrece un diámetro extragrande.
- Three blade stainless steel propeller.
- Offers good acceleration & all-round performance.
- Smaller pitch sizes offered in extra large diameter with increased blade area.
- Eliche di acciaio inox a 3 pale.
- Buona accelerazione.
- Piccole dimensione che offre un più grande diametro.



## HÉLICES ALUMINO E INOXIDABLES DE 3 Y 4 PALAS 3 & 4 BLADE ALUMINUM & STAINLESS STEEL PROPELLERS ELICHE ALLUMINIO E INOX DA 3 E 4 PALE

SISTEMA CODIGO REFERENCIAS  
PART NO. CODING SYSTEM  
SISTEMA DI CODICE

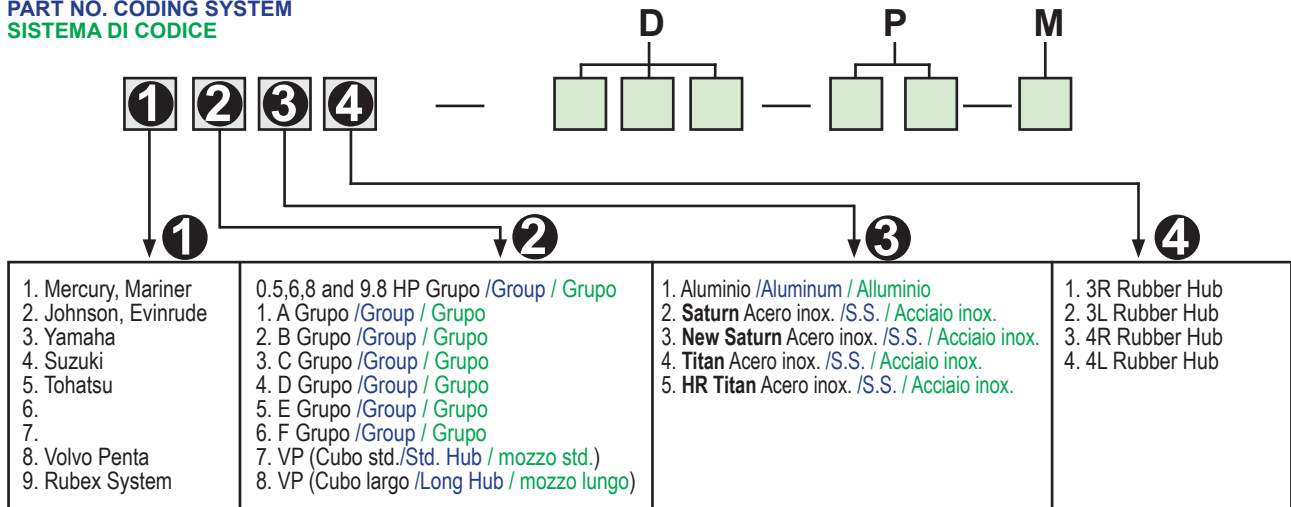

Ejemplo / Note / Esempio

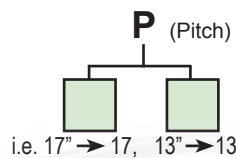
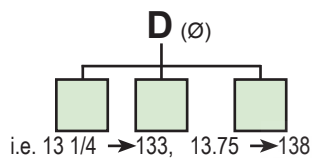

## GUÍA DE NÚCLEOS HUB KIT APLICACION CHAST GUIDA MOZZI INTERCambiabili



# RUBEX

MODELO MODEL MODELLO	REF. KIT	MODELO HÉLICE PROPELLER TYPE MODELLO ELICA
DT50, 50M (1983-84) DT55 (1985-97) DT60 (1983-84) DT65 (1985-97) 13 Estrias / tooth spline / Scalanature	RBX-115	C
DF70A, DF80A, DF90A (4T/ strokes) (2009+) 15 Estrias / tooth spline / Scalanature	RBX-150	D
DF90, DF115 (4T/ strokes) (2001+) 15 Estrias / tooth spline / Scalanature	RBX-125	D
DF140 (4T/ strokes) (2001+) 15 Estrias / tooth spline / Scalanature	RBX-126	D
75-140 HP DF60/ DF70 (1979+) 13 Estrias / tooth spline / Scalanature	RBX-110	D
DT150-225 HP (2T/ strokes) (1986+) DF150-300 HP 15 Estrias / tooth spline / Scalanature	RBX-104	E

## GUÍA HÉLICES ALUMINIO PROPELLERS ALUMINUM CHART GUIDA ELICHE ALLUMINIO

Modelo / Model / Modello <b>C</b> 30-75 H.P. 3 PALAS / 3 BLADE / 3 PALE				
B	D	P	R	Ref.
3	12.1	9	R	SOL9311-121-09
3	12	10	R	SOL9311-120-10
3	11.6	11	R	SOL9311-116-11
3	11.4	12	R	SOL9311-114-12
3	11.1	13	R	SOL9311-111-13
3	11.1	14	R	SOL9311-111-14
3	11	15	R	SOL9311-110-15

Modelo / Model / Modello <b>D</b> 40-14 H.P. 3 PALAS / 3 BLADE / 3 PALE				
B	D	P	R	Ref.
3	14	9	R	SOL9411-140-09
3	14	11	R	SOL9411-140-11
3	13.75	13	R	SOL9411-138-12
3	13.5	15	R	SOL9411-135-15
3	13.25	17	R	SOL9411-133-17
3	13.2	19	R	SOL9411-132-19
3	13.2	21	R	SOL9411-132-21

Modelo / Model / Modello <b>E</b> 135-350 H.P. 3 PALAS / 3 BLADE / 3 PALE				
B	D	P	R	Ref.
3	15.5	11	R	SOL9511-155-11
3	15.3	13	R	SOL9511-153-13
3	16	13	R	SOL9511-160-13
3	15	15	R	SOL9511-150-15
3	15	15	L	SOL9511-150-15
3	14.8	17	R	SOL9511-148-17
3	14.8	17	L	SOL9511-148-17
3	14.5	19	R	SOL9511-145-19
3	14.5	19	L	SOL9511-145-19
3	14.3	21	R	SOL9511-143-21
3	14.3	21	L	SOL9511-143-21

# RUBEX

Helice de aluminio con núcleo intercambiable (no incluido).  
Aluminium interchangeable hub propellers (not included).  
Eliche in alluminio con mozzo intercambiabile (non incluso).



## GUÍA HÉLICES INOX. STAINLESS STEEL PROPELLERS APPLICATION CHART GUIDA ELICHE INOX

Modelo / Model / Modello <b>C</b> 30-75 H.P. 3 PALAS / 3 BLADE / 3 PALE				
B	D	P	R	Ref.
3	11 5/8	11	R	SOL9331-116-11
3	11 3/8	12	R	SOL9331-114-12
3	11 1/8	13	R	SOL9331-111-13
3	11 1/8	14	R	SOL9331-111-14
3	11	15	R	SOL9331-110-15

Modelo / Model / Modello <b>D</b> 40-14 H.P. 3 PALAS / 3 BLADE / 3 PALE				
B	D	P	R	Ref.
3	13 3/4	13	R	SOL9431-138-13
3	13 3/4	13	L	SOL9432-138-13
3	13 1/2	15	R	SOL9431-135-15
3	13 1/2	15	L	SOL9432-135-15
3	13 1/4	17	R	SOL9431-133-17
3	13 1/4	17	L	SOL9432-133-17
3	13	19	R	SOL9431-130-19
3	13	19	L	SOL9432-130-19
3	13	21	R	SOL9431-130-21

Modelo / Model / Modello <b>E</b> 90-140 H.P. 3 PALAS / 3 BLADE / 3 PALE				
B	D	P	R	Ref.
3	14 1/2	15	R	SOL9531-145-15
3	14 1/2	15	L	SOL9532-145-15
3	14 1/4	17	R	SOL9531-143-17
3	14 1/4	17	L	SOL9532-143-17
3	14	19	R	SOL9531-140-19
3	14	19	L	SOL9532-140-19
3	14	21	R	SOL9531-140-21
3	14	21	L	SOL9532-140-21
3	14	23	R	SOL9531-140-23
3	14	23	L	SOL9532-140-23

Modelo / Model / Modello <b>E</b> 135-350 H.P. 3 PALAS / 3 BLADE / 3 PALE				
B	D	P	R	Ref.
3	15 3/4	15	R	SOL9571-158-15
3	15 3/4	15	L	SOL9572-158-15
3	15 1/2	17	R	SOL9571-155-17
3	15 1/2	17	L	SOL9572-155-17
3	15 1/4	19	R	SOL9571-153-19
3	15 1/4	19	L	SOL9572-153-19
3	15	21	R	SOL9571-153-21
3	15	21	L	SOL9572-153-21
3	14 3/4	23	R	SOL9571-148-23
3	14 3/4	23	L	SOL9572-148-23
3	14 1/2	25	R	SOL9571-145-25
3	14 1/2	25	L	SOL9572-145-25

# RUBEX



Helice de acero inox. con núcleo intercambiable (no incluido).  
Stainless steel interchangeable hub propellers (not included).  
Eliche di acciaio inox con mozzo intercambiabile (non incluso).